



OWNER'S MANUAL



XT500E

XT600E

4PT-28199-E6

Welcome to the Yamaha world of motorcycling!

As the owner of a XT500E/XT600E, you are benefiting from Yamaha's vast experience in and newest technology for the design and the manufacture of high-quality products, which have earned Yamaha a reputation for dependability.

Please take the time to read this manual thoroughly, so as to enjoy all your XT500E/XT600E's advantages. The owner's manual does not only instruct you in how to operate, inspect and maintain your motorcycle, but also in how to safeguard yourself and others from trouble and injury.

In addition, the many tips given in this manual will help to keep your motorcycle in the best possible condition. If you have any further questions, do not hesitate to contact your Yamaha dealer.

The Yamaha team wishes you many safe and pleasant rides. So, remember to put safety first!

IMPORTANT MANUAL INFORMATION

Particularly important information is distinguished in this manual by the following notations:



The Safety Alert Symbol means ATTENTION! BECOME ALERT! YOUR SAFETY IS INVOLVED!



Failure to follow WARNING instructions could result in severe injury or death to the motorcycle operator, a bystander or a person inspecting or repairing the motorcycle.

CAUTION:

A CAUTION indicates special precautions that must be taken to avoid damage to the motorcycle.

NOTE:

A NOTE provides key information to make procedures easier or clearer.

NOTE:

- This manual should be considered a permanent part of this motorcycle and should remain with it even if the motorcycle is subsequently sold.
 - Yamaha continually seeks advancements in product design and quality. Therefore, while this manual contains the most current product information available at the time of printing, there may be minor discrepancies between your motorcycle and this manual. If there is any question concerning this manual, please consult your Yamaha dealer.
-

IMPORTANT MANUAL INFORMATION

EW000002

⚠️ WARNING

PLEASE READ THIS MANUAL CAREFULLY AND COMPLETELY BEFORE OPERATING THIS MOTORCYCLE.

EAU03337

**XT500E/XT600E
OWNER'S MANUAL**

© 2000 by Yamaha Motor Co., Ltd.

1st Edition, December 2000

All rights reserved.

**Any reprinting or unauthorized use
without the written permission of
Yamaha Motor Co., Ltd.
is expressly prohibited.**

Printed in Japan.

TABLE OF CONTENTS

1 GIVE SAFETY THE RIGHT OF WAY

1

2 DESCRIPTION

2

3 INSTRUMENT AND CONTROL FUNCTIONS

3

4 PRE-OPERATION CHECKS

4

5 OPERATION AND IMPORTANT RIDING POINTS

5

6 PERIODIC MAINTENANCE AND MINOR REPAIR

6

7 MOTORCYCLE CARE AND STORAGE

7

8 SPECIFICATIONS

8

9 CONSUMER INFORMATION

9

INDEX



GIVE SAFETY THE RIGHT OF WAY

GIVE SAFETY THE RIGHT OF WAY1-1



GIVE SAFETY THE RIGHT OF WAY

Motorcycles are fascinating vehicles, which can give you an unsurpassed feeling of power and freedom. However, they also impose certain limits, which you must accept; even the best motorcycle does not ignore the laws of physics.

Regular care and maintenance are essential for preserving your motorcycle's value and operating condition. Moreover, what is true for the motorcycle is also true for the rider: good performance depends on being in good shape. Riding under the influence of medication, drugs and alcohol is, of course, out of the question. Motorcycle riders more than car drivers must always be at their mental and physical best. Under the influence of even small amounts of alcohol, there is a tendency to take dangerous risks.

Protective clothing is as essential for the motorcycle rider as seat belts are for car drivers and passengers. Always wear a complete motorcycle suit (whether made of leather or tear-resistant synthetic materials with protectors), sturdy boots, motorcycle gloves and a properly fitting helmet. Optimum protective wear, however, should not encourage carelessness. Though full-coverage helmets and suits, in particular, create an illusion of total safety and protection, motorcyclists will always be vulnerable. Riders who lack critical self-control run the risk of going too fast and are apt to take chances. This is even more dangerous in wet weather. The good motorcyclist rides safely, predictably and defensively avoiding all dangers, including those caused by others.

Enjoy your ride!

Left view	2-1
Right view	2-2
Controls/Instruments	2-3

DESCRIPTION

Left view

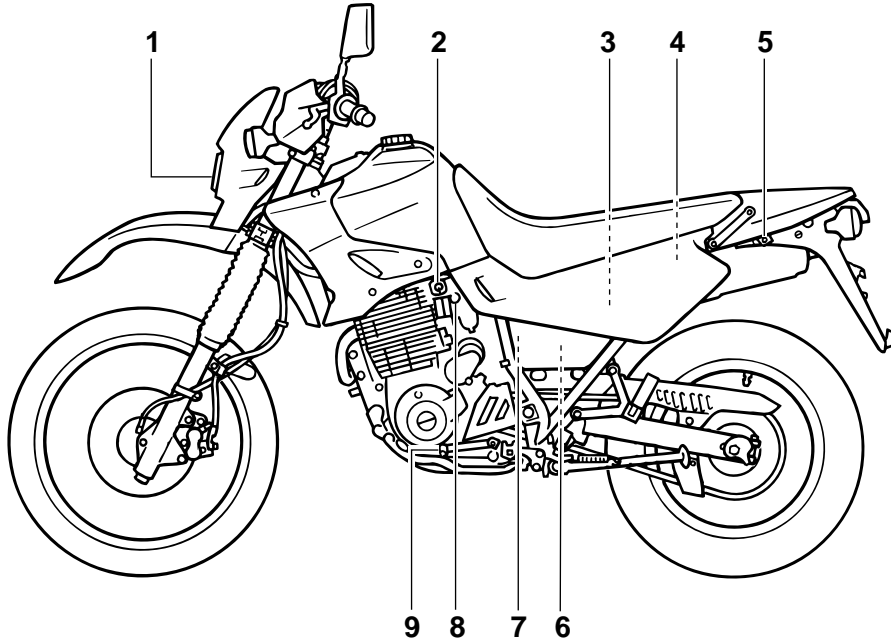

- | | | | |
|------------------|-------------|--|-------------|
| 1. Headlight | (page 6-29) | 6. Rear shock absorber spring preload
adjusting nut | (page 3-10) |
| 2. Fuel cock | (page 3-7) | 7. Fuse | (page 6-28) |
| 3. Battery | (page 6-28) | 8. Starter (choke) | (page 3-8) |
| 4. Tool kit | (page 6-1) | 9. Shift pedal | (page 3-5) |
| 5. Helmet holder | (page 3-9) | | |

Right view

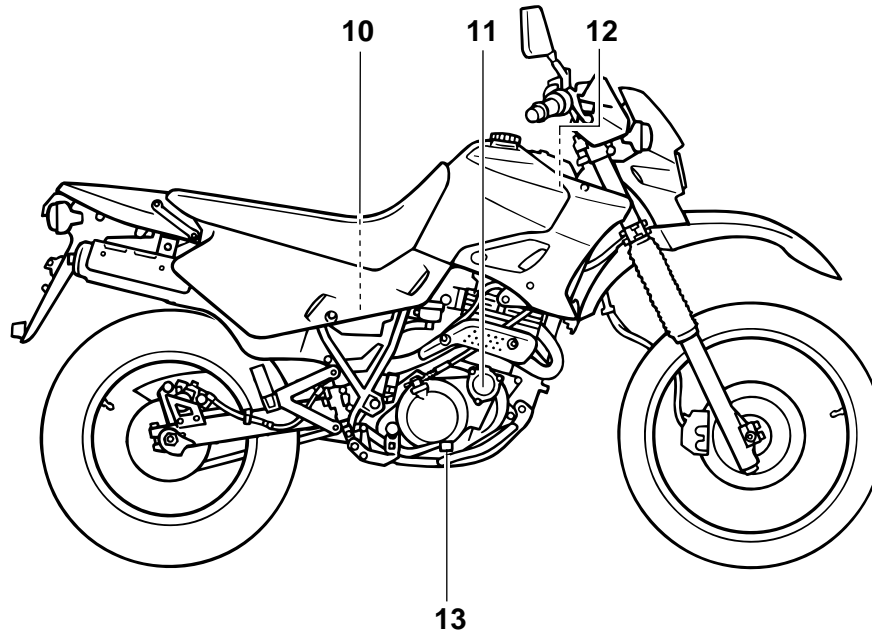

- | | |
|-------------------------|------------------|
| 10. Air filter | (page 6-12) |
| 11. Oil filter | (page 6-11) |
| 12. Engine oil dipstick | (page 6-10) |
| 13. Rear brake pedal | (page 3-5, 6-19) |

DESCRIPTION

Controls/Instruments

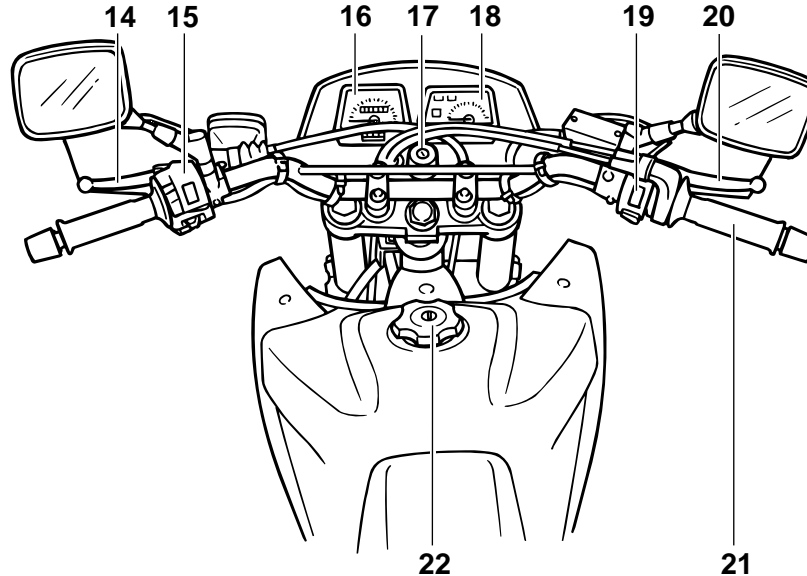

- | | | | |
|-------------------------------|------------------|------------------------------|------------------|
| 14. Clutch lever | (page 3-4, 6-18) | 19. Right handlebar switches | (page 3-4) |
| 15. Left handlebar switches | (page 3-3) | 20. Front brake lever | (page 3-5, 6-18) |
| 16. Speedometer | (page 3-2) | 21. Throttle grip | (page 6-24) |
| 17. Main switch/steering lock | (page 3-1) | 22. Fuel tank cap | (page 3-6) |
| 18. Tachometer | (page 3-3) | | |

INSTRUMENT AND CONTROL FUNCTIONS

Main switch/steering lock.....	3-1
Indicator lights	3-2
Speedometer	3-2
Tachometer	3-3
Handlebar switches	3-3
Clutch lever.....	3-4
Shift pedal.....	3-5
Front brake lever	3-5
Rear brake pedal	3-5
Fuel tank cap	3-6
Fuel.....	3-6
Fuel cock	3-7
Starter (choke) “ ”	3-8
Seat	3-9
Helmet holder	3-9
Rear shock absorber adjustment.....	3-10
Sidestand.....	3-11
Sidestand/clutch switch operation check.....	3-12

INSTRUMENT AND CONTROL FUNCTIONS

EW000016

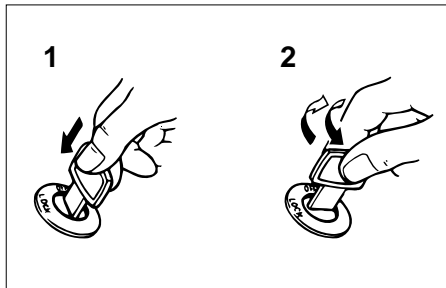
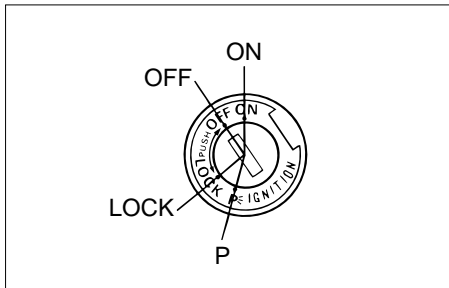

1. Push

2. Turn

⚠ WARNING

Never turn the key to "OFF" or "LOCK" when the motorcycle is moving. The electrical circuits will be switched off which may result in loss of control or an accident. Be sure the motorcycle is stopped before turning the key to "OFF" or "LOCK".

EAU00029

Main switch/steering lock

The main switch controls the ignition and lighting systems. Its operation is described below.

EAU00036

ON

Electrical circuits are switched on. The engine can be started. The key cannot be removed in this position.

EAU00038

OFF

All electrical circuits are switched off. The key can be removed in this position.

EAU00042

LOCK

The steering is locked in this position and all electrical circuits are switched off.

The key can be removed in this position.

To lock the steering, turn the handlebars all the way to the left. With the key at "OFF", push it into the main switch and release it, turn it counter-clockwise to "LOCK" and remove it.

To release the lock, turn the key to "OFF".

EAU01590

P (Parking)

The steering is locked in this position, and the taillight and auxiliary light come on but all other circuits are off. The key can be removed in this position.

To use the parking position, first lock the steering, then turn the key to "P". Do not use this position for an extended length of time as the battery may discharge.

INSTRUMENT AND CONTROL FUNCTIONS

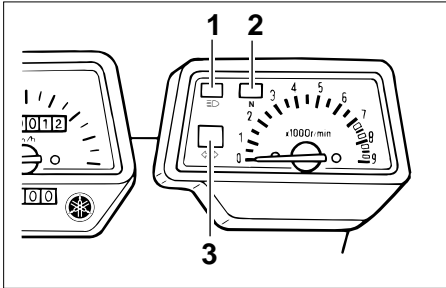

1. High beam indicator light “≡D”
2. Neutral indicator light “N”
3. Turn indicator light “↔”

EAU00056

Indicator lights

EAU00057

Turn indicator light “↔”

This indicator flashes when the turn switch is moved to the left or right.

EAU00061

Neutral indicator light “N”

This indicator comes on when the transmission is in neutral.

EAU00063

High beam indicator light “≡D”

This indicator comes on when the headlight high beam is used.

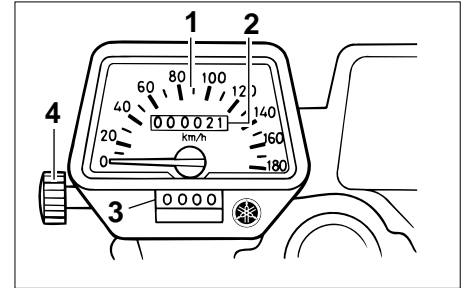

1. Speedometer
2. Odometer
3. Trip odometer
4. Reset knob

EAU00095

Speedometer

The speedometer shows riding speed. This speedometer is equipped with an odometer and trip odometer. The trip odometer can be reset to “0” with the reset knob. Use the trip odometer to estimate how far you can ride on a tank of fuel. This information will enable you to plan fuel stops in the future.

INSTRUMENT AND CONTROL FUNCTIONS

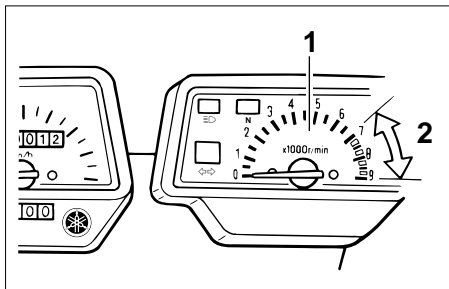

1. Tachometer
2. Red zone

EAU00102

Tachometer

This model is equipped with a tachometer so the rider can monitor the engine speed and keep it within the ideal power range.

EC000003

CAUTION:

**Do not operate in the red zone.
Red zone: 7,000 r/min and above**

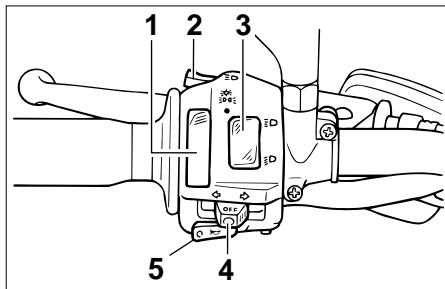

1. Lights switch
2. Pass switch “≡D”
3. Dimmer switch
4. Turn signal switch
5. Horn switch “D”

EAU00118

Handlebar switches

EAU00134

Lights switch

Turning the light switch to “>D<”, turns on the auxiliary light, meter lights and taillight. Turning the light switch to “D”, turns the headlight on also.

EAU00119

Pass switch “≡D”

Press the switch to operate the passing light.

EAU00121

Dimmer switch

Turn the switch to “≡D” for the high beam and to “D” for the low beam.

EAU00127

Turn signal switch

To signal a right-hand turn, push the switch to “>”. To signal a left-hand turn, push the switch to “<”. Once the switch is released it will return to the center position. To cancel the signal, push the switch in after it has returned to the center position.

EAU00129

Horn switch “D”

Press the switch to sound the horn.

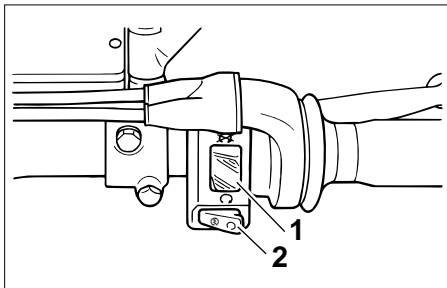

1. Engine stop switch
2. Start switch “”

EAU00138

Engine stop switch

The engine stop switch is a safety device for use in an emergency such as when the motorcycle overturns or if trouble occurs in the throttle system. Turn the switch to “” to start the engine.

In case of emergency, turn the switch to “” to stop the engine.

Start switch “”

The starter motor cranks the engine when pushing the start switch.

EAU00143

EC000005

CAUTION:

See starting instructions prior to starting the engine.

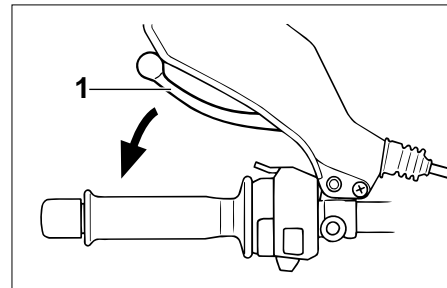

1. Clutch lever

EAU00152

Clutch lever

The clutch lever is located on the left handlebar, and the ignition circuit cut-off system is incorporated in the clutch lever holder. Pull the clutch lever to the handlebar to disengage the clutch, and release the lever to engage the clutch. The lever should be pulled rapidly and released slowly for smooth clutch operation. (Refer to the engine starting procedures for a description of the ignition circuit cut-off system.)

INSTRUMENT AND CONTROL FUNCTIONS

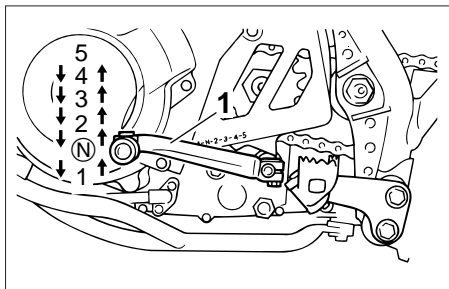

- 1. Shift pedal
- N. Neutral

EAU00157

Shift pedal

This motorcycle is equipped with a constant-mesh 5-speed transmission. The shift pedal is located on the left side of the engine and is used in combination with the clutch when shifting.

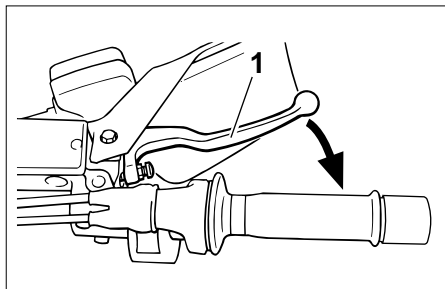

- 1. Front brake lever

EAU00158

Front brake lever

The front brake lever is located on the right handlebar. Pull it toward the handlebar to apply the front brake.

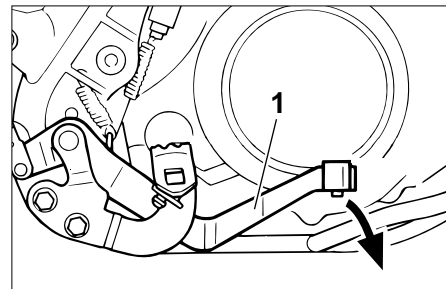

- 1. Rear brake pedal

EAU00162

Rear brake pedal

The rear brake pedal is on the right side of the motorcycle. Press down on the brake pedal to apply the rear brake.

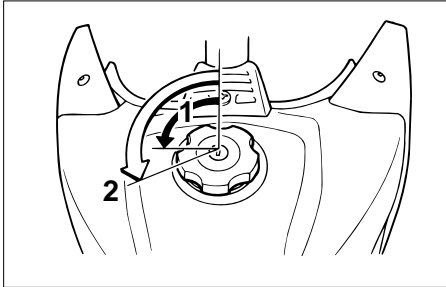

1. Unlock
2. Open

EAU00177

Fuel tank cap

To open

Insert the key and turn it 1/4 turn counterclockwise. Turn the cap 1/3 turn counterclockwise and remove it from the tank.

To close

Put the cap in the filler neck and turn it 1/3 turn clockwise. Lock the cap by turning the key 1/4 turn clockwise, and remove the key.

NOTE: _____
The tank cap cannot be reinstalled unless it is unlocked. The key must remain in the cap until the cap is properly installed and locked onto the fuel tank.

EW000023

WARNING

Be sure the cap is properly installed and locked in place before riding the motorcycle.

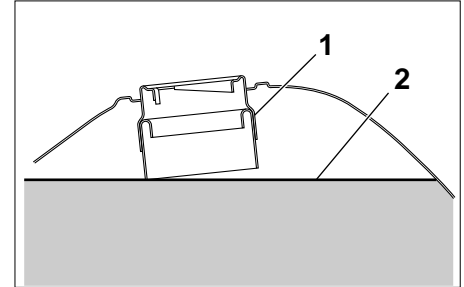

1. Filler tube
2. Fuel level

EAU01183

Fuel

Make sure there is sufficient fuel in the tank. Fill the fuel tank to the bottom of the filler tube as shown in the illustration.

EW000130

WARNING

Do not overfill the fuel tank. Avoid spilling fuel on the hot engine. Do not fill the fuel tank above the bottom of the filler tube or it may overflow when the fuel heats up later and expands.

INSTRUMENT AND CONTROL FUNCTIONS

EAU00185

CAUTION:

Always wipe off spilled fuel immediately with a dry and clean soft cloth. Fuel may deteriorate painted surfaces or plastic parts.

EAU00191

Recommended fuel:

Regular unleaded gasoline with a research octane number of 91 or higher.

Fuel tank capacity:

Total:
15.0 L
Reserve:
2.0 L

NOTE:

If knocking or pinging occurs, use a different brand of gasoline or higher octane grade.

OFF: closed position

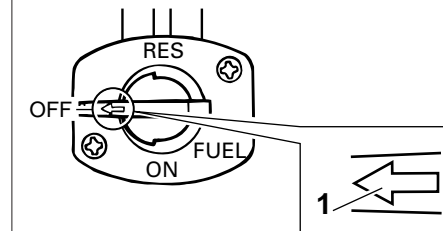

1. Arrow mark pointing to "OFF"

EAU03050

Fuel cock

The fuel cock supplies fuel from the tank to the carburetor while filtering it also.

The fuel cock has three positions:

OFF

With the lever in this position, fuel will not flow. Always return the lever to this position when the engine is not running.

INSTRUMENT AND CONTROL FUNCTIONS

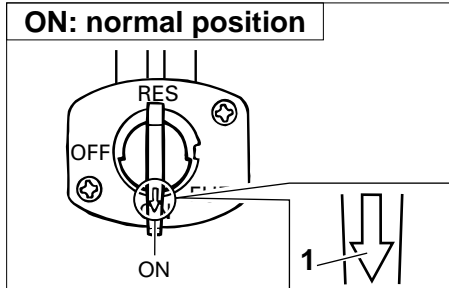

1. Arrow mark pointing to "ON"

ON

With the lever in this position, fuel flows to the carburetor. Normal riding is done with the lever in this position.

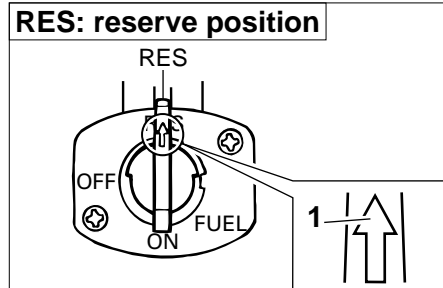

1. Arrow mark pointing to "RES"

RES

This indicates reserve. If you run out of fuel while riding, move the lever to this position. Fill the tank at the first opportunity. Be sure to set the lever back to "ON" after refueling!

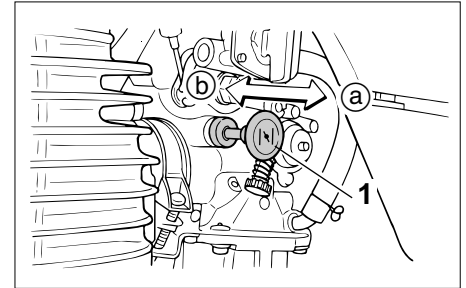

1. Starter (choke) "1"

Starter (choke) "1"

Starting a cold engine requires a richer air-fuel mixture. A separate starter circuit supplies this mixture.

Move in direction (a) to turn on the starter (choke).

Move in direction (b) to turn off the starter (choke).

EAU00210

INSTRUMENT AND CONTROL FUNCTIONS

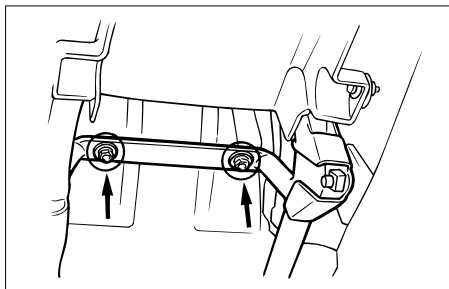

EAU00240

Seat

To remove the seat, remove the bolts.

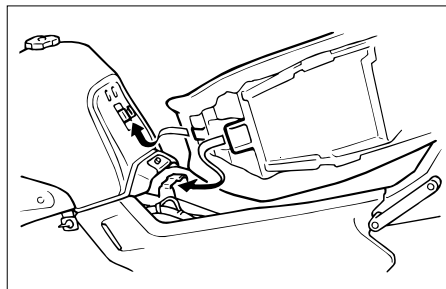

When reinstalling the seat, insert the projections on the front of the seat into the holders, then tighten the bolts.

NOTE: _____
Make sure that the seat is securely fitted.

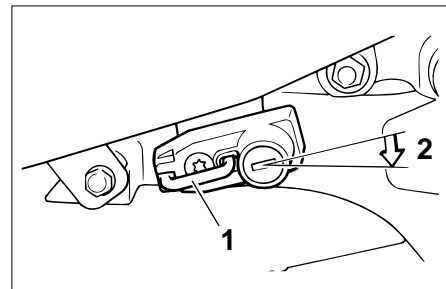

1. Helmet holder
2. Open

EAU00260

Helmet holder

To open the helmet holder, insert the key in the lock and turn it as shown. To lock the helmet holder, replace the holder in its original position.

EW000030

⚠ WARNING

Never ride with a helmet in the helmet holder. The helmet may hit objects, causing loss of control and possibly an accident.

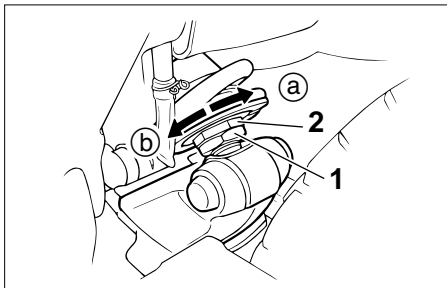

1. Locknut
2. Adjusting nut

EAU01650

Rear shock absorber adjustment

This shock absorber is equipped with a spring preload adjuster. Adjust spring preload as follows.

1. Loosen the locknut.
2. Turn the adjusting nut in direction (a) to increase spring preload and in direction (b) to decrease spring preload. The spring preload is determined by the spring set length.

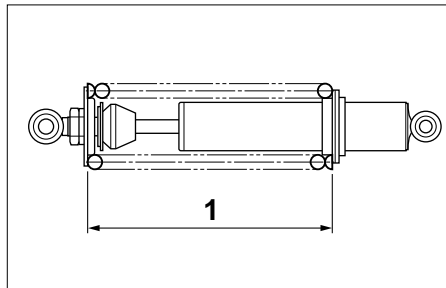

1. Measuring distance "A"

Shortening spring set length increases spring preload, lengthening spring set length decreases spring preload.

Spring preload:

Minimum (soft):

Distance "A" = 248.5 mm

Standard:

Distance "A" = 243 mm

Maximum (hard):

Distance "A" = 237.5 mm

CAUTION: _____

Never attempt to turn an adjuster beyond the maximum or minimum setting.

3. Tighten the locknut to the specified torque.

Tightening torque:

Locknut:

42 Nm (4.2 m·kg)

CAUTION: _____

Always tighten the locknut against the spring adjusting nut and tighten the locknut to the specified torque.

INSTRUMENT AND CONTROL FUNCTIONS

EAU00315

⚠ WARNING

This shock absorber contains highly pressurized nitrogen gas. Read and understand the following information before handling the shock absorber. The manufacturer cannot be held responsible for property damage or personal injury that may result from improper handling.

- Do not tamper with or attempt to open the cylinder assembly.
 - Do not subject the shock absorber to an open flame or other high heat source. This may cause the unit to explode due to excessive gas pressure.
 - Do not deform or damage the cylinder in any way. Cylinder damage will result in poor damping performance.
 - Take your shock absorber to a Yamaha dealer for any service.
-

EAU00330

Sidestand

This model is equipped with an ignition circuit cut-off system. The motorcycle must not be ridden when the sidestand is down. The sidestand is located on the left side of the frame. (Refer to page 5-1 for an explanation of this system.)

EW000044

⚠ WARNING

This motorcycle must not be operated with the sidestand in the down position. If the stand is not properly retracted, it could contact the ground and distract the operator, resulting in a possible loss of control. Yamaha has designed into this motorcycle a lockout system to assist the operator in fulfilling the responsibility of retracting the sidestand. Please check carefully the operating instructions listed below and if there is any indication of a malfunction, return the motorcycle to a Yamaha dealer immediately for repair.

EAU00331

Sidestand/clutch switch operation check

Check the operation of the sidestand switch and clutch switch against the information below.

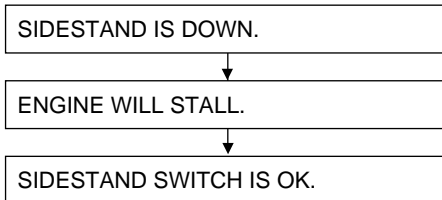
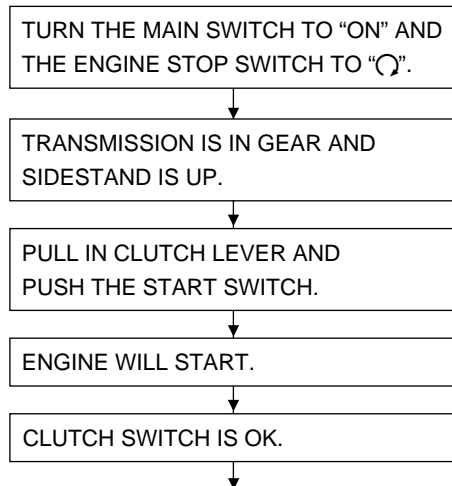

EW000045

⚠ WARNING

If improper operation is noted, consult a Yamaha dealer immediately.

Pre-operation check list.....4-1

PRE-OPERATION CHECKS

Owners are personally responsible for their vehicle's condition. Your motorcycle's vital functions can start to deteriorate quickly and unexpectedly, even if it remains unused (for instance, if it is exposed to the elements). Any damage, fluid leak or loss of tire pressure could have serious consequences. Therefore, it is very important that, in addition to a thorough visual inspection, you check the following points before each ride.

PRE-OPERATION CHECK LIST

ITEM	CHECKS	PAGE
Front brake	<ul style="list-style-type: none"> • Check operation, free play, fluid level and vehicle for fluid leakage. • Fill with DOT 4 (or DOT 3) brake fluid if necessary. 	3-5, 6-18 ~ 6-22
Rear brake	<ul style="list-style-type: none"> • Check operation, free play, fluid level and vehicle for fluid leakage. • Fill with DOT 4 brake fluid if necessary. 	
Clutch	<ul style="list-style-type: none"> • Check operation, condition and free play. • Adjust if necessary. 	3-4, 6-18
Throttle grip and housing	<ul style="list-style-type: none"> • Check for smooth operation. • Lubricate. 	6-24
Engine oil	<ul style="list-style-type: none"> • Check oil level. • Fill with oil if necessary. 	6-10 ~ 6-12
Drive chain	<ul style="list-style-type: none"> • Check chain slack and condition. • Adjust if necessary. 	6-22 ~ 6-24
Wheels and tires	<ul style="list-style-type: none"> • Check tire pressure, wear, damage and spoke tightness. • Tighten spokes if necessary. 	6-15 ~ 6-17
Control and meter cable	<ul style="list-style-type: none"> • Check for smooth operation. • Lubricate if necessary. 	6-24
Brake and shift pedal shafts	<ul style="list-style-type: none"> • Check for smooth operation. • Lubricate if necessary. 	6-25
Brake and clutch lever pivots	<ul style="list-style-type: none"> • Check for smooth operation. • Lubricate if necessary. 	6-25

PRE-OPERATION CHECKS

ITEM	CHECKS	PAGE
Sidestand pivot	<ul style="list-style-type: none">• Check for smooth operation.• Lubricate if necessary.	6-25
Chassis fasteners	<ul style="list-style-type: none">• Make sure that all nuts, bolts, and screws are properly tightened.• Tighten if necessary.	—
Fuel tank	<ul style="list-style-type: none">• Check fuel level.• Fill with fuel if necessary.	3-6 ~ 3-7
Lights, signals and switches	<ul style="list-style-type: none">• Check for proper operation.	6-29 ~ 6-32

NOTE:

Pre-operation checks should be made each time the motorcycle is used. Such an inspection can be accomplished in a very short time; and the added safety it assures is more than worth the time involved.

⚠ WARNING

If any item in the Pre-Operation Check is not working properly, have it inspected and repaired before operating the motorcycle.

OPERATION AND IMPORTANT RIDING POINTS

Starting the engine	5-1
Starting a warm engine.....	5-3
Shifting.....	5-4
Recommended shift point (for Switzerland only)	5-4
Tips for reducing fuel consumption.....	5-5
Engine break-in	5-5
Parking	5-6

OPERATION AND IMPORTANT RIDING POINTS

⚠ WARNING

EAU00373

- Before riding this motorcycle, become thoroughly familiar with all operating controls and their functions. Consult a Yamaha dealer regarding any control or function that you do not thoroughly understand.
- Never start your engine or let it run for any length of time in a closed area. The exhaust fumes are poisonous and can cause loss of consciousness and death within a short time. Always operate your motorcycle in an area with adequate ventilation.
- Before starting out, always be sure the sidestand is up. Failure to retract the sidestand completely can result in a serious accident when you try to turn a corner.

Starting the engine

EAU00311

NOTE:

This motorcycle is equipped with an ignition circuit cut-off system. The engine can be started only under one of the following conditions:

- The transmission is in neutral.
- The sidestand is up, the transmission is in gear and the clutch is disengaged.

The motorcycle must not be ridden when the sidestand is down.

⚠ WARNING

EW000054

Before going through the following steps, check the function of the sidestand switch and clutch switch. (Refer to page 3-12.)

OPERATION AND IMPORTANT RIDING POINTS

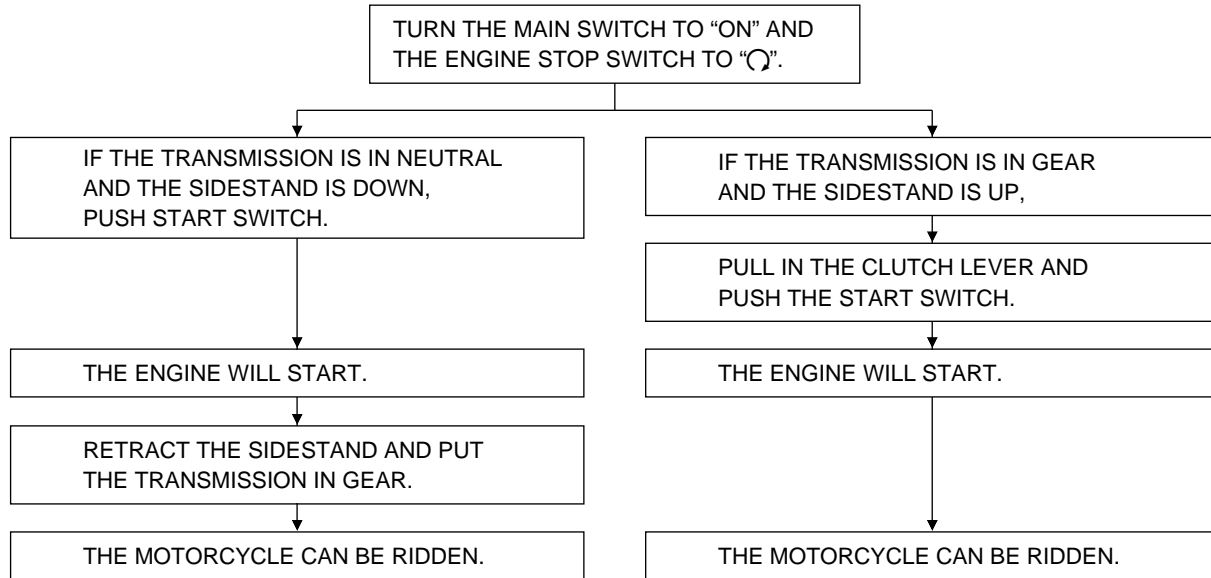

OPERATION AND IMPORTANT RIDING POINTS

1. Turn the fuel cock to “ON”.
2. Turn the main switch to “ON” and the engine stop switch to “

NOTE: _____

When the transmission is in neutral, the neutral indicator light should be on. If the light does not come on, ask a Yamaha dealer to inspect it.

4. Turn on the starter (choke) and completely close the throttle grip.
5. Start the engine by pushing the start switch.

NOTE: _____

If the engine fails to start, release the start switch, wait a few seconds, then try again. Each attempt should be as short as possible to preserve the battery. Do not crank the engine more than 10 seconds on any one attempt.

6. After starting the engine, move the starter (choke) to the halfway position.

NOTE: _____

For maximum engine life, never accelerate hard with a cold engine!

7. After warming up the engine, turn off the starter (choke) completely.

NOTE: _____

The engine is warm when it responds normally to the throttle with the starter (choke) turned off.

EAU01258

Starting a warm engine

The starter (choke) is not required when the engine is warm.

EC000046

CAUTION: _____

See the “Engine break-in” section prior to operating the motorcycle for the first time.

ECU000048

EAU02941

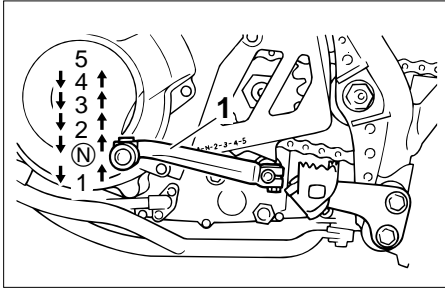

- 1. Shift pedal
- N. Neutral

EAU00423

Shifting

The transmission lets you control the amount of power you have available at a given speed for starting, accelerating, climbing hills, etc. The use of the shift pedal is shown in the illustration.

To shift into neutral, depress the shift pedal repeatedly until it reaches the end of its travel, then raise the pedal slightly.

CAUTION:

- Do not coast for long periods with the engine off, and do not tow the motorcycle a long distance. Even with gears in neutral, the transmission is only properly lubricated when the engine is running. Inadequate lubrication may damage the transmission.
- Always use the clutch when changing gears. The engine, transmission, and driveline are not designed to withstand the shock of forced shifting and can be damaged by shifting without using the clutch.

Recommended shift points (for Switzerland only)

The recommended shift points are shown in the table below.

	Acceleration shift point (km/h)
1st → 2nd	23
2nd → 3rd	36
3rd → 4th	50
4th → 5th	60

NOTE:

When shifting two gears down from 4th to 2nd, bring your motorcycle to a speed of 35 km/h.

OPERATION AND IMPORTANT RIDING POINTS

Tips for reducing fuel consumption

EAU00424

Your motorcycle's fuel consumption depends to a large extent on your riding style. The following tips can help reduce fuel consumption:

- Warm up the engine before riding.
- Turn off the starter (choke) as soon as possible.
- Shift up swiftly and avoid high engine speeds during acceleration.
- Do not double-clutch or rev the engine while shifting down and avoid high engine speeds with no load on the engine.
- Turn off the engine instead of letting it idle for an extended length of time, i.e. in traffic jams, at traffic lights or railroad crossings.

Engine break-in

EAU00436

There is never a more important period in the life of your motorcycle than the period between zero and 1,000 km. For this reason we ask that you carefully read the following material. Because the engine is brand new, you must not put an excessive load on it for the first 1,000 km. The various parts in the engine wear and polish themselves to the correct operating clearances. During this period, prolonged full throttle operation, or any condition which might result in excessive heating of the engine, must be avoided.

0 ~ 150 km

Avoid operation above 4,000 r/min. Stop the engine and let it cool for 5 to 10 minutes after every hour of operation. Vary the speed of the motorcycle from time to time. Do not operate it at one set throttle position.

150 ~ 500 km

Avoid prolonged operation above 5,000 r/min. Rev the motorcycle freely through the gears, but do not use full throttle at any time.

500 ~ 1,000 km

Avoid prolonged full throttle operation. Avoid cruising speeds in excess of 6,000 r/min.

EAU00440

EC000052

CAUTION: _____

After 1,000 km of operation, be sure to replace the engine oil and oil filter.

1,000 km and beyond
Full throttle can be used.

EC000053

CAUTION: _____

- Never let engine speeds enter the red zone.
 - If any engine trouble should occur during the break-in period, consult a Yamaha dealer immediately.
-

EAU00457

Parking

When parking the motorcycle, stop the engine and remove the ignition key. Turn the fuel cock to “OFF” whenever stopping the engine.

EW000058

⚠ WARNING _____

The exhaust system is hot. Park the motorcycle in a place where pedestrians or children are not likely to touch the motorcycle. Do not park the motorcycle on a slope or soft ground; the motorcycle may overturn.

PERIODIC MAINTENANCE AND MINOR REPAIR

Tool kit	6-1	Drive chain lubrication.....	6-23
Periodic maintenance and lubrication chart	6-3	Cable inspection and lubrication	6-24
Cowling and panel removal and installation.....	6-6	Throttle cable and grip lubrication	6-24
Cowling A.....	6-7	Brake and shift pedal lubrication	6-25
Panel A, B.....	6-7	Brake and clutch lever lubrication	6-25
Spark plug.....	6-8	Sidestand lubrication.....	6-25
Engine oil	6-10	Rear suspension lubrication.....	6-26
Air filter.....	6-12	Front fork inspection	6-26
Carburetor adjustment	6-13	Steering inspection	6-27
Idle speed adjustment.....	6-14	Wheel bearings	6-27
Throttle cable free play adjustment.....	6-14	Battery.....	6-28
Valve clearance adjustment.....	6-15	Fuse replacement	6-29
Tires	6-15	Headlight bulb replacement	6-29
Wheels	6-17	Turn signal light bulb replacement	6-31
Clutch lever free play adjustment.....	6-18	Taillight bulb replacement	6-32
Front brake lever free play adjustment	6-18	Supporting the motorcycle	6-32
Rear brake pedal height adjustment.....	6-19	Front wheel removal	6-33
Brake light switch adjustment	6-20	Front wheel installation	6-34
Checking the front and rear brake pads.....	6-20	Rear wheel removal.....	6-35
Inspecting the brake fluid level.....	6-21	Rear wheel installation.....	6-36
Brake fluid replacement	6-22	Troubleshooting	6-36
Drive chain slack check	6-22	Troubleshooting chart	6-37
Drive chain slack adjustment	6-23		

PERIODIC MAINTENANCE AND MINOR REPAIR

EAU00464

Periodic inspection, adjustment and lubrication will keep your motorcycle in the safest and most efficient condition possible. Safety is an obligation of the motorcycle owner. The maintenance and lubrication schedule chart should be considered strictly as a guide to general maintenance and lubrication intervals.

YOU MUST TAKE INTO CONSIDERATION THAT WEATHER, TERRAIN, GEOGRAPHICAL LOCATIONS, AND A VARIETY OF INDIVIDUAL USES ALL TEND TO DEMAND THAT EACH OWNER ALTER THIS TIME SCHEDULE TO SHORTER INTERVALS TO MATCH THE ENVIRONMENT. The most important points of motorcycle inspection, adjustment, and lubrication are explained in the following pages.

EW00060

⚠ WARNING

If you are not familiar with motorcycle service, this work should be done by a Yamaha dealer.

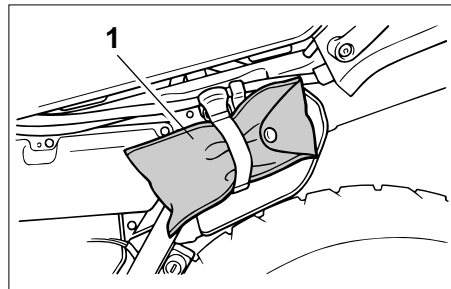

1. Tool kit

EAU01175

Tool kit

The tool kit is located behind panel A. (See page 6-7 for panel removal and installation procedures.) The tools provided in the owner's tool kit are to assist you in the performance of periodic maintenance. However, some other tools such as a torque wrench are also necessary to perform the maintenance correctly.

The service information included in this manual is intended to provide you, the owner, with the necessary information for completing some of your own preventive maintenance and minor repairs.

PERIODIC MAINTENANCE AND MINOR REPAIR

NOTE: _____

If you do not have necessary tools required during a service operation, take your motorcycle to a Yamaha dealer for service.

EW000063

⚠ WARNING _____

Modifications to this motorcycle not approved by Yamaha may cause loss of performance, and render it unsafe for use. Consult a Yamaha dealer before attempting any changes.

PERIODIC MAINTENANCE AND MINOR REPAIR

EAU03685

Periodic maintenance and lubrication chart

NOTE:

- The annual checks must be performed every year, except if a kilometer-based maintenance is performed instead.
- From 50,000 km, repeat the maintenance intervals starting from 10,000 km.
- Items marked with an asterisk should be performed by a Yamaha dealer as they require special tools, data and technical skills.

NO.	ITEM	CHECK OR MAINTENANCE JOB	ODOMETER READING (× 1,000 km)					ANNUAL CHECK
			1	10	20	30	40	
1	* Fuel line	• Check fuel hoses for cracks or damage.		√	√	√	√	√
2	Spark plug	• Check condition. • Clean and regap.		√		√		
		• Replace.			√		√	
3	* Valves	• Check valve clearance. • Adjust.		√	√	√	√	
4	Air filter element	• Clean.		√		√		
		• Replace.			√		√	
5	Clutch	• Check operation. • Adjust.	√	√	√	√	√	
6	* Front brake	• Check operation, fluid level and vehicle for fluid leakage. (See NOTE on page 6-5.)	√	√	√	√	√	√
		• Replace brake pads.	Whenever worn to the limit					
7	* Rear brake	• Check operation, fluid level and vehicle for fluid leakage. (See NOTE on page 6-5.)	√	√	√	√	√	√
		• Replace brake pads.	Whenever worn to the limit					
8	* Brake hoses	• Check for cracks or damage.		√	√	√	√	√
		• Replace. (See NOTE on page 6-5.)	Every 4 years					

PERIODIC MAINTENANCE AND MINOR REPAIR

NO.	ITEM	CHECK OR MAINTENANCE JOB	ODOMETER READING (× 1,000 km)					ANNUAL CHECK
			1	10	20	30	40	
9	* Wheels	<ul style="list-style-type: none"> • Check runout, spoke tightness and for damage. • Tighten spokes if necessary. 		√	√	√	√	
10	* Tires	<ul style="list-style-type: none"> • Check tread depth and for damage. • Replace if necessary. • Check air pressure. • Correct if necessary. 		√	√	√	√	
11	* Wheel bearings	<ul style="list-style-type: none"> • Check bearing for looseness or damage. 		√	√	√	√	
12	* Swingarm	<ul style="list-style-type: none"> • Check operation and for excessive play. 		√	√	√	√	
13	Drive chain	<ul style="list-style-type: none"> • Check chain slack. • Make sure that the rear wheel is properly aligned. • Clean and lubricate. 	Every 500 km and after washing the motorcycle or riding in the rain.					
14	* Steering bearings	<ul style="list-style-type: none"> • Check bearing play and steering for roughness. • Lubricate with lithium-soap-based grease. 	√	√	√	√	√	
15	* Chassis fasteners	<ul style="list-style-type: none"> • Make sure that all nuts, bolts and screws are properly tightened. 		√	√	√	√	√
16	Sidestand	<ul style="list-style-type: none"> • Check operation. • Lubricate. 		√	√	√	√	√
17	* Sidestand switch	<ul style="list-style-type: none"> • Check operation. 	√	√	√	√	√	√
18	* Front fork	<ul style="list-style-type: none"> • Check operation and for oil leakage. 		√	√	√	√	
19	* Shock absorber assembly	<ul style="list-style-type: none"> • Check operation and shock absorber for oil leakage. 		√	√	√	√	

PERIODIC MAINTENANCE AND MINOR REPAIR

NO.	ITEM	CHECK OR MAINTENANCE JOB	ODOMETER READING ($\times 1,000$ km)					ANNUAL CHECK
			1	10	20	30	40	
20 *	Rear suspension relay arm and connecting arm pivoting points	• Check operation.		√	√	√	√	
		• Lubricate with molybdenum disulfide grease.			√		√	
21 *	Carburetor	• Check starter (choke) operation. • Adjust engine idling speed.	√	√	√	√	√	√
22	Engine oil	• Change.	√	√	√	√	√	√
23	Engine oil filter element	• Replace.	√		√		√	
24 *	Front and rear brake switches	• Check operation.	√	√	√	√	√	√
25	Moving parts and cables	• Lubricate.		√	√	√	√	√
26 *	Lights, signals and switches	• Check operation. • Adjust headlight beam.	√	√	√	√	√	√

EAU03884

6

NOTE:

- The air filter needs more frequent service if you are riding in unusually wet or dusty areas.
- Hydraulic brake service
 - Regularly check and, if necessary, correct the brake fluid level.
 - Every two years replace the internal components of the brake master cylinders and calipers, and change the brake fluid.
 - Replace the brake hoses every four years and if cracked or damaged.

PERIODIC MAINTENANCE AND MINOR REPAIR

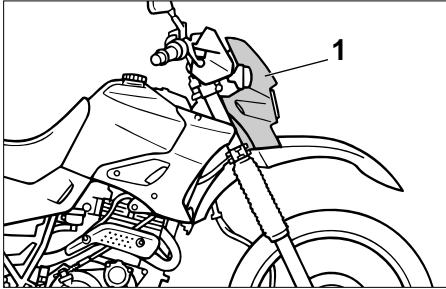

1. Cowling A

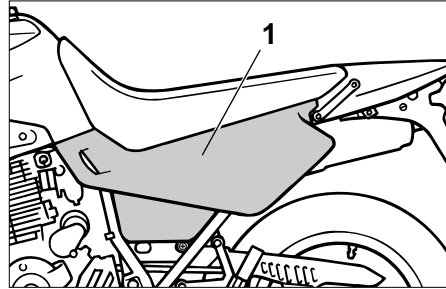

1. Panel A

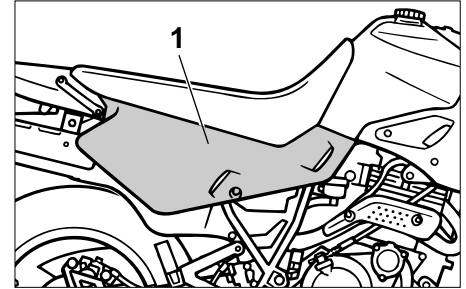

1. Panel B

EAU01139

Cowling and panel removal and installation

The cowlings and panels illustrated need to be removed to perform some of the maintenance described in this chapter.

Refer to this section each time a cowling or panel has to be removed or reinstalled.

PERIODIC MAINTENANCE AND MINOR REPAIR

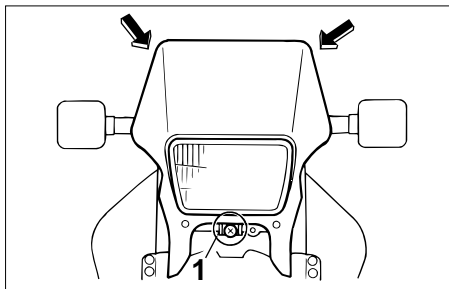

1. Screw

EAU01145

Cowling A

To remove

Remove the cowling screw and pull outward on the areas shown.

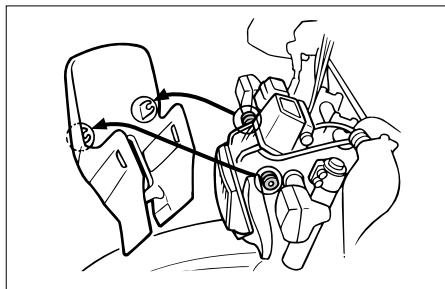

To install

Place in the original position and install the screw.

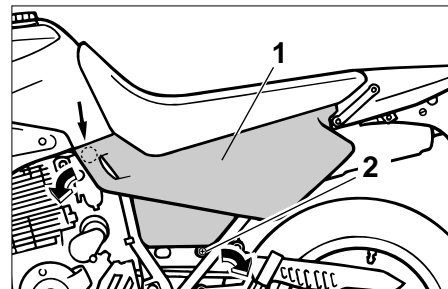

1. Panel A
2. Screw

EAU00488

Panel A

To remove

Remove the screw and pull outward on the areas shown.

To install

Place the panel in the original position and install the screw.

PERIODIC MAINTENANCE AND MINOR REPAIR

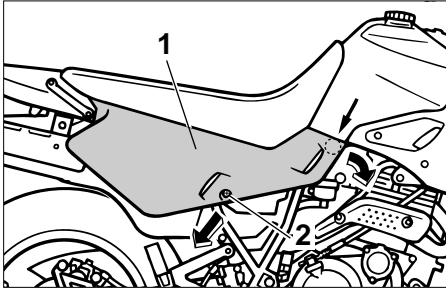

1. Panel B
2. Screw

EAU00488

Panel B

To remove

Remove the screw and pull outward on the areas shown.

To install

Place the panel in the original position and install the screw.

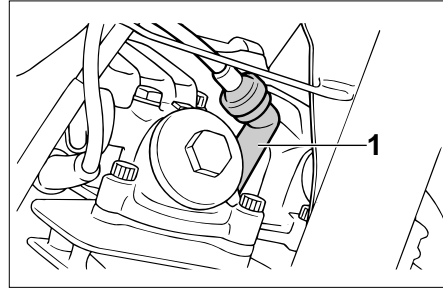

1. Spark plug cap

EAU01833

Spark plug

Removal

1. Remove the spark plug cap.

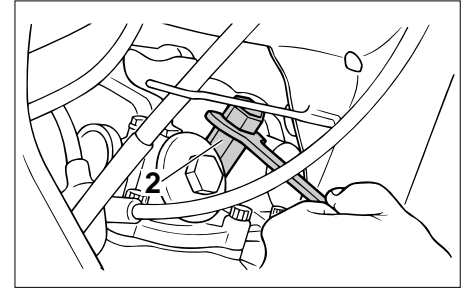

1. Spark plug wrench
2. Use the spark plug wrench in the tool kit to remove the spark plug as shown.

PERIODIC MAINTENANCE AND MINOR REPAIR

Inspection

The spark plug is an important engine component and is easy to inspect. The condition of the spark plug can indicate the condition of the engine.

The ideal color on the white insulator around the center electrode is a medium-to-light tan color for a motorcycle that is being ridden normally.

Do not attempt to diagnose such problems yourself. Instead, take the motorcycle to a Yamaha dealer. You should periodically remove and inspect the spark plug because heat and deposits will cause any spark plug to slowly break down and erode. If electrode erosion becomes excessive, or if carbon and other deposits are excessive, you should replace the spark plug with the specified plug.

Specified spark plug:
DPR8EA-9 or
DPR9EA-9 (NGK)

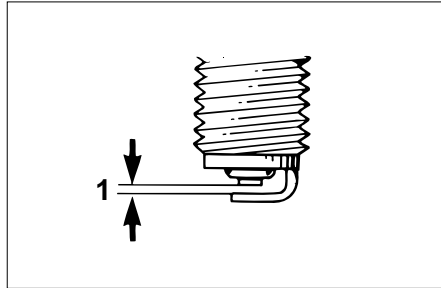

1. Spark plug gap

Installation

1. Measure the electrode gap with a wire thickness gauge and, if necessary, adjust the gap to specification.

Spark plug gap:
0.8 ~ 0.9 mm

2. Clean the gasket surface. Wipe off any grime from the threads.
3. Install the spark plug and tighten it to the specified torque.

Tightening torque:
Spark plug:
17.5 Nm (1.75 m·kg)

NOTE:

If a torque wrench is not available when you are installing a spark plug, a good estimate of the correct torque is 1/4 to 1/2 turn past finger tight. Have the spark plug tightened to the specified torque as soon as possible.

4. Install the spark plug cap.

PERIODIC MAINTENANCE AND MINOR REPAIR

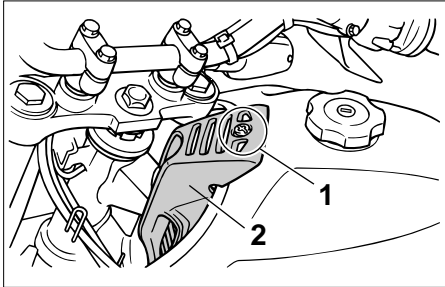

1. Screw
2. Cover

EAU00526*

Engine oil

Oil level measurement

1. Place the motorcycle on a level place and hold it in an upright position.
2. Remove the screw and pull outward on the oil tank cap cover to remove it.
3. Start the engine and warm it up.

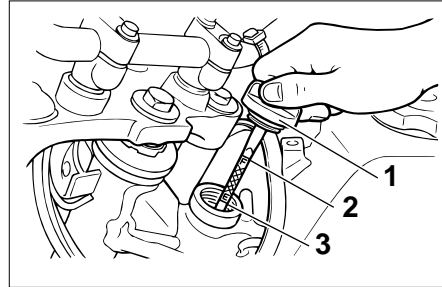

1. Oil tank cap/dipstick
2. Maximum level mark
3. Minimum level mark
4. Idle the engine for at least 10 seconds and stop it. While keeping the motorcycle upright, remove the dipstick (oil tank cap) and check the oil level.
5. The oil level should be between the minimum and maximum marks. If the level is low, fill with oil to the maximum level line.

EC000000

CAUTION:

Do not run the motorcycle until you know it has sufficient engine oil.

EW000065

WARNING

Never remove the dipstick just after high-speed operation. Hot oil could spout out, causing danger. Always wait until the oil cools down before removing the dipstick.

PERIODIC MAINTENANCE AND MINOR REPAIR

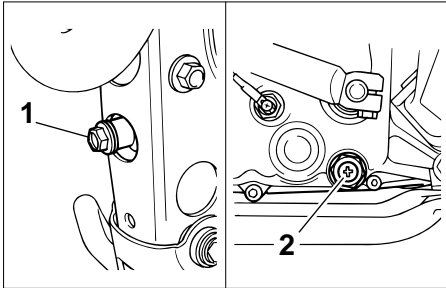

1. Drain bolt (oil tank)
2. Drain bolt (crankcase)

Engine oil and oil filter element replacement

1. Warm up the engine for a few minutes.
2. Place an oil pan under the engine.
3. Remove the oil tank cap, drain bolts.

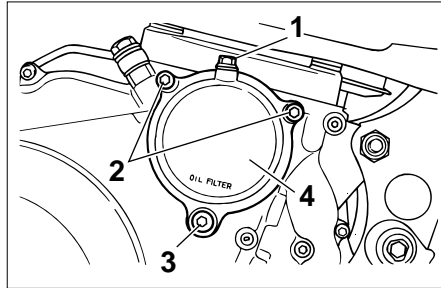

1. Air bleed screw
 2. Oil filter cover bolt (×2)
 3. Oil filter drain bolt
 4. Oil filter cover
4. Check each gasket. If damaged, replace.
 5. Remove the filter cover bolts and the oil filter cover. Replace the oil filter element.

NOTE:

The oil filter cover is secured by three bolts. The lower one should be removed first so that the filter cavity will drain.

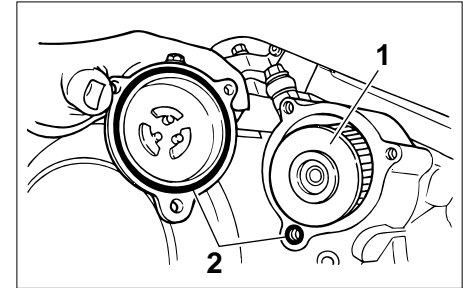

1. Oil filter element
 2. O-ring (×2)
6. Check the O-rings for damage. Replace if damaged.
 7. Install the drain plugs, filter cover and bolts. Tighten to the specified torque.

PERIODIC MAINTENANCE AND MINOR REPAIR

Tightening torque:

Drain plug (crankcase):

30 Nm (3.0 m·kg)

Drain plug (oil tank):

17.5 Nm (1.75 m·kg)

Filter cover bolt:

10 Nm (1.0 m·kg)

Air bleed screw:

5 Nm (0.5 m·kg)

8. Fill the engine with oil. Install the oil tank cap.

Recommended oil:

See page 8-1

Oil quantity:

Total amount:

3.3 L

Periodic oil change:

2.7 L

With oil filter replacement:

2.8 L

9. Start the engine and warm it up for a few minutes. While warming up, check for oil leakage. If oil leakage is found, stop the engine immediately and check for the cause.
10. Stop the engine and check the oil level.

EC000076

CAUTION:

After replacing the engine oil, be sure to check the oil pressure as described below.

- Remove the air bleed screw from the oil filter cover.
- Start the engine and keep it idling until oil flows out of the bleed hole. If no oil comes out after one minute, turn off the engine immediately so it will not seize. In such a case go to the nearest Yamaha dealer for repairs.
- After checking, tighten the air bleed screw securely.

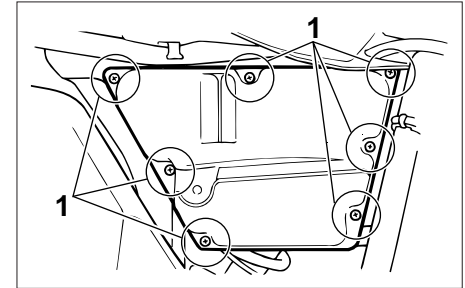

1. Screw (x7)

EAU01083

Air filter

The air filter should be cleaned at the specified intervals. It should be cleaned more frequently if you are riding in unusually wet or dusty areas.

1. Remove panel B. (See page 6-7 for panel removal and installation procedures.)
2. Remove the air filter case fitting screws and the filter case cover.

PERIODIC MAINTENANCE AND MINOR REPAIR

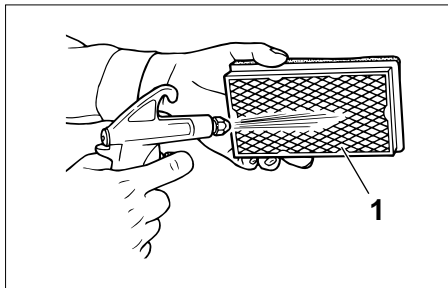

1. Mesh side

3. Remove the air filter.
4. Tap the air filter lightly to remove most of the dust and dirt and blow out the remaining dirt with compressed air from the mesh side of the air filter. If it is damaged, replace it.

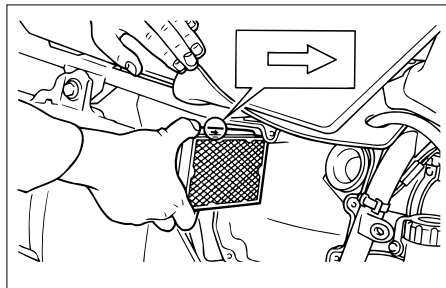

5. Install the air filter with the arrow mark on the top pointing inward.
6. Install the air filter case cover and the panel.

CAUTION:

- Make sure the air filter is properly seated in the air filter case.
- The engine should never be run without the air filter installed. Excessive piston and/or cylinder wear may result.

Carburetor adjustment

EAU00629

The carburetor is a vital part of the engine and requires very sophisticated adjustment. Most adjustments should be left to a Yamaha dealer who has the professional knowledge and experience to do so. However, the following may be serviced by the owner as part of routine maintenance.

CAUTION:

EC000094

The carburetor was set at the Yamaha factory after many tests. If the settings are changed, poor engine performance and damage may result.

PERIODIC MAINTENANCE AND MINOR REPAIR

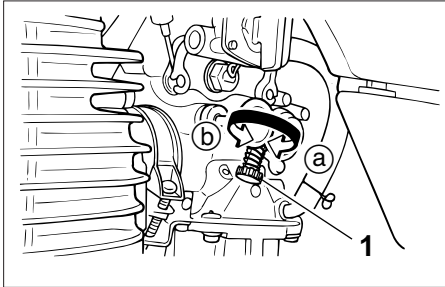

1. Throttle stop screw

EAU00632

Idle speed adjustment

1. Start the engine and warm it up for a few minutes at approximately 1,000 to 2,000 r/min. Occasionally rev the engine to 4,000 to 5,000 r/min. The engine is warm when it quickly responds to the throttle.
2. Set the idle to the specified engine speed by adjusting the throttle stop screw. Turn the screw in direction (a) to increase engine speed and in direction (b) to decrease engine speed.

Standard idle speed:
1,200 ~ 1,400 r/min
(Except for CH)
1,300 ~ 1,400 r/min
(For CH)

NOTE:

If the specified idle speed cannot be obtained by performing the above adjustment, consult a Yamaha dealer.

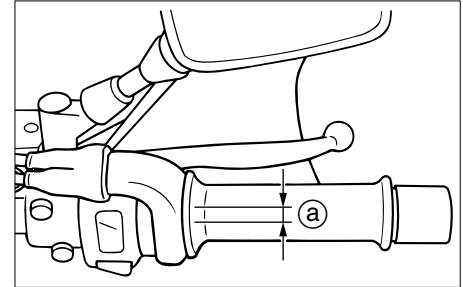

- a. Free play

EAU00635

Throttle cable free play inspection

There should be a free play of 3 ~ 5 mm at the throttle grip. If the free play is incorrect, ask a Yamaha dealer to make this adjustment.

PERIODIC MAINTENANCE AND MINOR REPAIR

EAU00637

Valve clearance adjustment

The correct valve clearance changes with use, resulting in improper fuel/air supply or engine noise. To prevent this, the valve clearance must be adjusted regularly. This adjustment however, should be left to a professional Yamaha service technician.

EAU00652

Tires

To ensure maximum performance, long service and safe operation, note the following:

Tire air pressure

Always check and adjust the tire pressure before operating the motorcycle.

EW000082

⚠ WARNING

Tire inflation pressure should be checked and adjusted when the temperature of the tire equals the ambient air temperature. Tire inflation pressure must be adjusted according to total weight of cargo, rider, passenger, and accessories (fairing, saddlebags, etc. if approved for this model), and vehicle speed.

Maximum load*	176 kg (XT500E) 180 kg (XT600E)	
	Cold tire pressure:	Front
Up to 90 kg	150 kPa (1.5 kg/cm ² , 1.5 bar)	150 kPa (1.5 kg/cm ² , 1.5 bar)
90 kg load ~ Maximum load*	150 kPa (1.5 kg/cm ² , 1.5 bar)	225 kPa (2.25 kg/cm ² , 2.25 bar)
Off-road riding	125 kPa (1.25 kg/cm ² , 1.25 bar)	125 kPa (1.25 kg/cm ² , 1.25 bar)
High speed riding	150 kPa (1.5 kg/cm ² , 1.5 bar)	150 kPa (1.5 kg/cm ² , 1.5 bar)

* Load is the total weight of cargo, rider, passenger and accessories.

PERIODIC MAINTENANCE AND MINOR REPAIR

EW000083

⚠ WARNING

Proper loading of your motorcycle is important for several characteristics of your motorcycle, such as handling, braking, performance and safety. Do not carry loosely packed items that can shift. Securely pack your heaviest items close to the center of the motorcycle, and distribute the weight evenly from side to side. Properly adjust the suspension for your load, and check the condition and pressure of your tires. **NEVER OVERLOAD YOUR MOTORCYCLE.** Make sure the total weight of the cargo, rider, passenger, and accessories (fairing, saddlebags, etc. if approved for this model) does not exceed the maximum load of the motorcycle. Operation of an overloaded motorcycle could cause tire damage, an accident, or even injury.

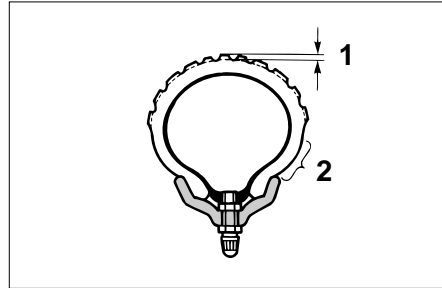

1. Tread depth
2. Side wall

Tire inspection

Always check the tires before operating the motorcycle. If center tread depth reaches the limit as shown, if the tire has a nail or glass fragments in it, or if the side wall is cracked, contact a Yamaha dealer immediately and have the tire replaced.

EW000078

⚠ WARNING

After extensive tests, the tires mentioned below have been approved by Yamaha Motor Co., Ltd. for this model. No guarantee for handling characteristics can be given if tire combinations other than what is approved are used on this motorcycle. The front and rear tires should be of the same manufacture and design.

FRONT

Manufacturer	Size	Type
BRIDGESTONE	90/90-21 54S	TW47
DUNLOP	90/90-21 54S	TRAIL MAX L

REAR

Manufacturer	Size	Type
BRIDGESTONE	120/90-17 64S	TW48
DUNLOP	120/90-17 64S	TRAIL MAX

Minimum tire tread depth (front and rear)	0.8 mm
---	--------

PERIODIC MAINTENANCE AND MINOR REPAIR

NOTE: _____

These limits may be different by regulation from country to country. If so, conform to the limits specified by the regulations of your own country.

⚠ WARNING _____

EAU00681

- **Operating the motorcycle with excessively worn tires decrease riding stability and can lead to loss of control. Have excessively worn tires replaced by a Yamaha dealer immediately. Brakes, tires, and related wheel parts replacement should be left to a Yamaha Service Technician.**
 - **Patching a punctured tube is not recommended. If it is absolutely necessary to do so, use great care and replace the tube as soon as possible with a good quality replacement.**
-

EAU00685

Wheels

To ensure maximum performance, long service, and safe operation, note the following:

- Always inspect the wheels before a ride. Check for cracks, bends or warpage of the wheel. Be sure the spokes are tight and undamaged. If any abnormal condition exists in a wheel, consult a Yamaha dealer. Do not attempt even small repairs to the wheel. If a wheel is deformed or cracked, it must be replaced.
- Tires and wheels should be balanced whenever either one is changed or replaced. Failure to have a wheel balanced can result in poor performance, adverse handling characteristics, and shortened tire life.
- Ride at moderate speeds after changing a tire since the tire surface must first be broken in for it to develop its optimal characteristics.

PERIODIC MAINTENANCE AND MINOR REPAIR

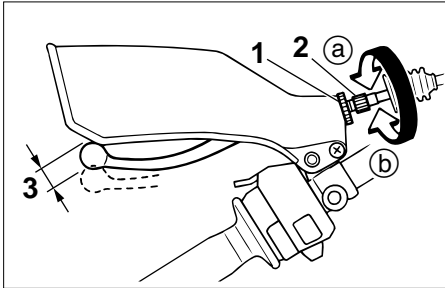

1. Locknut
2. Adjusting bolt
3. Free play

EAU00694

Clutch lever free play adjustment

The clutch lever free play should be adjusted to 10 ~ 15 mm.

1. Loosen the locknut at the clutch lever.
2. Turn the adjusting bolt at the clutch lever in direction (a) to increase free play or in direction (b) to decrease free play.
3. Tighten the locknut at the clutch lever.

If the specified free play cannot be obtained, proceed with the following steps.

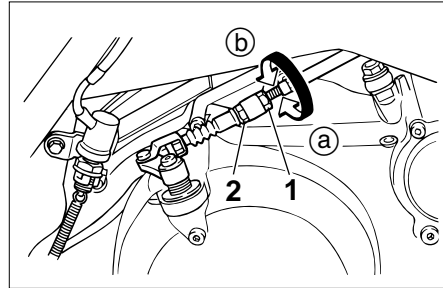

1. Adjusting nut
2. Locknut

4. Loosen the locknut at the clutch lever.
5. Turn the adjusting bolt at the clutch lever in direction (a) to loosen the cable.
6. Loosen the locknut at the crankcase side.
7. Turn the adjusting nut at the crankcase in direction (a) to increase free play or in direction (b) to decrease free play.
8. Tighten the locknut at the crankcase and the clutch lever.

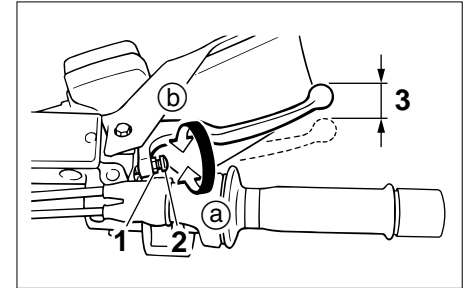

1. Locknut
2. Adjusting bolt
3. Free play

EAU00696

Front brake lever free play adjustment

The free play at the front brake lever should be 2 ~ 5 mm.

1. Loosen the locknut.
2. Turn the adjusting bolt in direction (a) to increase free play or in direction (b) to decrease free play.
3. After adjusting, tighten the locknut.

PERIODIC MAINTENANCE AND MINOR REPAIR

⚠ WARNING

EW000099

- Check the brake lever free play. Be sure the brake is working properly.
- A soft or spongy feeling in the brake lever can indicate the presence of air in the brake system. This air must be removed by bleeding the brake system before the motorcycle is operated. Air in the system will cause greatly diminished braking capability and can result in loss of control and an accident. Have a Yamaha dealer inspect and bleed the system if necessary.

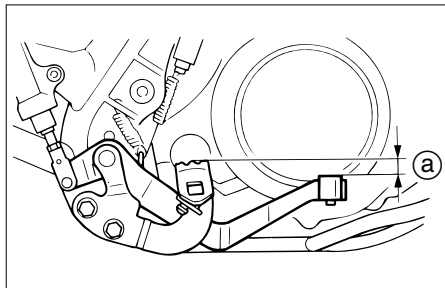

a. Pedal height

EAU00712

Rear brake pedal height adjustment

The top of the brake pedal should be positioned 12 mm below the top of the footrest. If not, ask a Yamaha dealer to adjust it.

⚠ WARNING

EW000109

A soft or spongy feeling in the brake pedal can indicate the presence of air in the brake system. This air must be removed by bleeding the brake system before the motorcycle is operated. Air in the system will cause greatly diminished braking capability and can result in loss of control and an accident. Have a Yamaha dealer inspect and bleed the system if necessary.

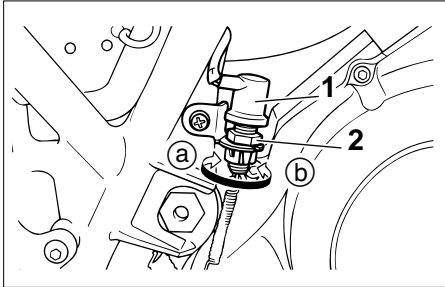

1. Brake light switch
2. Adjusting nut

EAU00713

Brake light switch adjustment

The rear brake light switch is activated by the brake pedal and is properly adjusted when the brake light comes on just before braking takes effect. To adjust the rear brake light switch, hold the switch body so it does not rotate while turning the adjusting nut.

Turn the adjusting nut in direction ① to make the brake light come on earlier.

Turn the adjusting nut in direction ② to make the brake light come on later.

EAU00716

Checking the front and rear brake pads

A wear indicator is provided on each brake. This indicator allows checking of brake pad wear without disassembling the brake. Apply the brake and inspect the wear indicator. If the brake pads are worn to wear limit, have a Yamaha dealer to replace the pads.

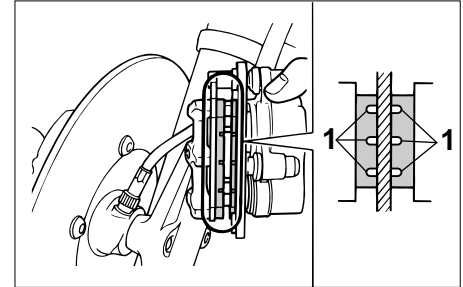

1. Wear indicator groove (×3)

EAU01119

Front brake

Wear indicator grooves are provided on each brake pad. These indicators allow checking of brake pad wear without disassembling the brake. Inspect the grooves. If they have almost disappeared, ask a Yamaha dealer to replace the pads.

PERIODIC MAINTENANCE AND MINOR REPAIR

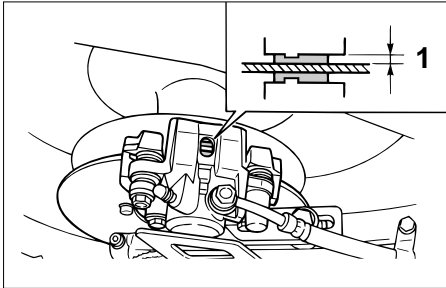

1. Wear limit: 0.8 mm

EAU00729

Rear brake

Remove the cap and inspect the pads. If the thickness is less than the specified value, have a Yamaha dealer replace the pads.

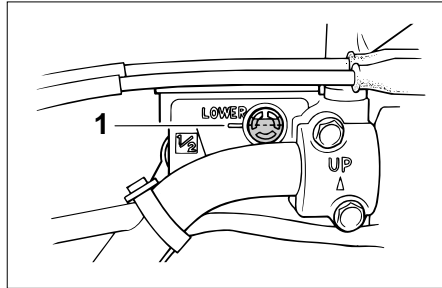

1. Minimum level mark

EAU00733

Inspecting the brake fluid level

Insufficient brake fluid may let air enter the brake system, possibly causing the brakes to become ineffective.

Before riding, check that the brake fluid is above the minimum level and replenish when necessary.

Observe these precautions:

- When checking the fluid level, make sure the top of the master cylinder is level by turning the handlebars.

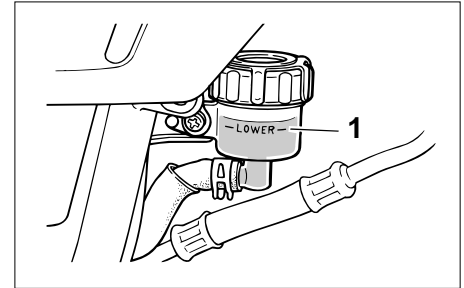

1. Minimum level mark

- Use only the designated quality brake fluid. Otherwise, the rubber seals may deteriorate, causing leakage and poor brake performance.

Recommended brake fluid:
DOT 4

NOTE: _____
If DOT 4 is not available, DOT 3 can be used for the front brake only.

PERIODIC MAINTENANCE AND MINOR REPAIR

- Refill with the same type of brake fluid. Mixing fluids may result in a harmful chemical reaction and lead to poor brake performance.
- Be careful that water does not enter the master cylinder when refilling. Water will significantly lower the boiling point of the fluid and may result in vapor lock.
- Brake fluid may deteriorate painted surfaces or plastic parts. Always clean up spilled fluid immediately.
- Have a Yamaha dealer check the cause if the brake fluid level goes down.

Brake fluid replacement

EAU00742

The brake fluid should be replaced only by trained Yamaha service personnel. Have the Yamaha dealer replace the following components during periodic maintenance or when they are damaged or leaking:

- oil seals (every two years)
- brake hoses (every four years)

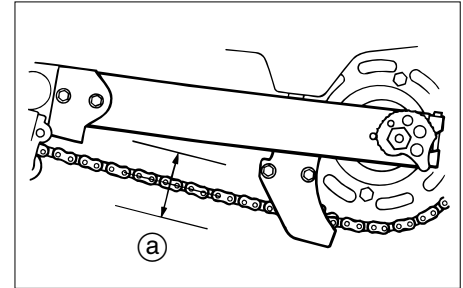

a. Chain slack

Drive chain slack check

EAU00744

NOTE:

Spin the wheel several times and find the tightest position of the chain. Check and/or adjust the chain slack while it's in this tightest position.

To check the chain slack the motorcycle must be held straight up with both wheels on the ground and without rider. Check the slack at the position shown in the illustration. Normal slack is approximately 30 ~ 40 mm. If the slack exceeds 40 mm, adjust.

PERIODIC MAINTENANCE AND MINOR REPAIR

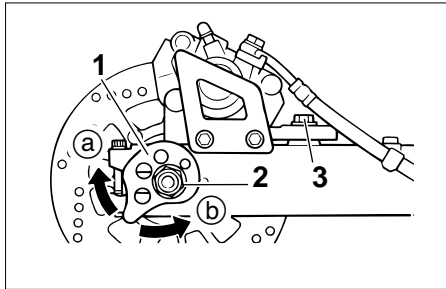

1. Chain adjusting plate
2. Axle nut
3. Caliper bracket bolt

EAU01134

Drive chain slack adjustment

1. Loosen the axle nut and caliper bracket bolt.
2. Turn both left and right chain adjusting plates the same amount. Make sure that they are in the same position for proper wheel alignment. To tighten the chain, turn in direction (a). To loosen the chain, turn in direction (b).

EC000096

CAUTION: _____

Too little chain slack will overload the engine and other vital parts. Keep the slack within the specified limits.

3. After adjusting, be sure to tighten the axle nut and caliper bracket bolt to the specified tightening torque.

Tightening torque:

Axle nut:

105 Nm (10.5 m·kg)

Caliper bracket bolt:

48 Nm (4.8 m·kg)

EAU03006

Drive chain lubrication

The chain consists of many parts which work with each other. If the chain is not maintained properly, it will wear out quickly. Therefore, the chain must be serviced regularly. This service is especially necessary when riding in dusty areas. This motorcycle is equipped with a sealed type chain. Steam cleaning, high-pressure washers, and solvents can damage the drive chain, so do not use these for cleaning it. Use only kerosene to clean the drive chain. Wipe it dry, and thoroughly lubricate it with SAE 30 ~ 50W motor oil. Do not use any other lubricants on the drive chain. They may contain solvents that could damage the sealed chain.

PERIODIC MAINTENANCE AND MINOR REPAIR

CAUTION:

EC000097

Be sure to oil the chain after washing the motorcycle or riding in the rain.

Cable inspection and lubrication

EAU02962

⚠ WARNING

EW000112

Damage to the outer housing of cables may lead to internal rusting and interfere with the cable movement. Replace damaged cables as soon as possible to prevent unsafe conditions.

Lubricate the cables and cable ends. If a cable does not operate smoothly, ask a Yamaha dealer to replace it.

Recommended lubricant:
Engine oil

Throttle cable and grip lubrication

EAU00773

The throttle twist grip assembly should be greased at the time that the cable is lubricated, since the grip must be removed to get at the end of the throttle cable. After removing the screws, hold the end of the cable up in the air and put in several drops of lubricant. With the throttle grip disassembled, coat the metal surface of the grip assembly with a suitable all-purpose grease.

PERIODIC MAINTENANCE AND MINOR REPAIR

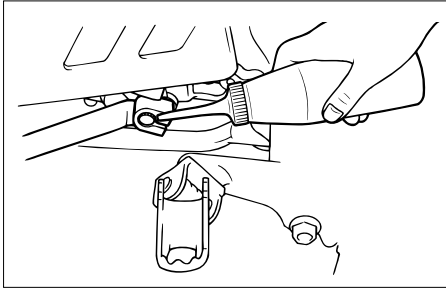

EAU02984

Brake and shift pedal lubrication

Lubricate the pivoting parts.

Recommended lubricant:
Engine oil

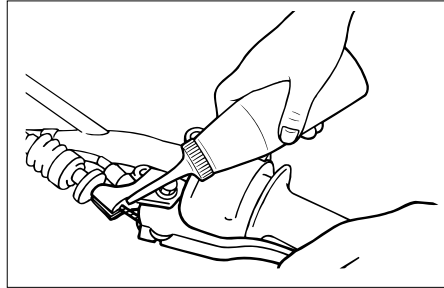

EAU02985

Brake and clutch lever lubrication

Lubricate the pivoting parts.

Recommended lubricant:
Engine oil

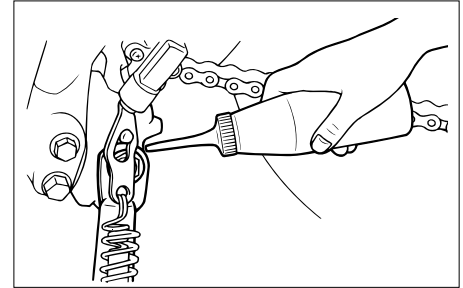

EAU02986

Sidestand lubrication

Lubricate the sidestand pivoting point and metal-to-metal contact surfaces. Check that the sidestand moves up and down smoothly.

Recommended lubricant:
Engine oil

EW000113

⚠ WARNING

If the sidestand does not move smoothly, consult a Yamaha dealer.

PERIODIC MAINTENANCE AND MINOR REPAIR

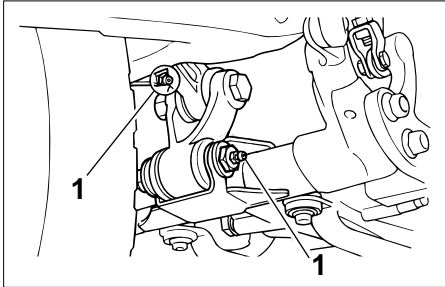

1. Grease nipple (x2)

EAU00790

Rear suspension lubrication

Lubricate the pivoting parts.

Recommended lubricant:
Molybdenum disulfide grease

Front fork inspection

Visual check

EAU02939

⚠ WARNING

EW000115

Securely support the motorcycle so there is no danger of it falling over.

Check for scratches or damage on the inner tube and excessive oil leakage from the front fork.

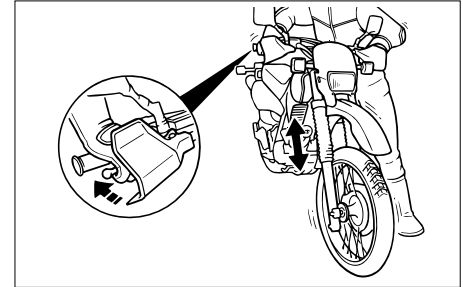

Operation check

1. Place the motorcycle on a level place.
2. Hold the motorcycle in an upright position and apply the front brake.
3. Push down hard on the handlebars several times and check if the fork rebounds smoothly.

EC000098

CAUTION:

If any damage or unsmooth movement is found with the front fork, consult a Yamaha dealer.

PERIODIC MAINTENANCE AND MINOR REPAIR

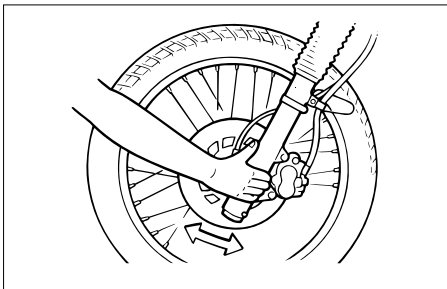

EAU00794

Steering inspection

Periodically inspect the condition of the steering. Worn out or loose steering bearings may be dangerous. Place a stand under the engine to raise the front wheel off the ground. Hold the lower end of the front forks and try to move them forward and backward. If any free play can be felt, ask a Yamaha dealer to inspect and adjust the steering. Inspection is easier if the front wheel is removed.

EW000115

⚠ WARNING

Securely support the motorcycle so there is no danger of it falling over.

EAU01144

Wheel bearings

If there is play in the front or rear wheel hub or if the wheel does not turn smoothly, have a Yamaha dealer inspect the wheel bearings.

PERIODIC MAINTENANCE AND MINOR REPAIR

Battery

EAU00800

This motorcycle is equipped with a sealed-type battery. Therefore it is not necessary to check the electrolyte or fill the battery with distilled water.

- If the battery seems to have discharged, consult a Yamaha dealer.
- If the motorcycle is equipped with optional electrical accessories, the battery tends to discharge more quickly, so be sure to recharge it periodically.

CAUTION:

EC000101

Never try to remove the sealing caps of the battery cells. The battery will be damaged.

EW000116

⚠ WARNING

Battery electrolyte is poisonous and dangerous, causing severe burns, etc. It contains sulfuric acid. Avoid contact with skin, eyes or clothing.

ANTIDOTE:

- **EXTERNAL:** Flush with water.
- **INTERNAL:** Drink large quantities of water or milk. Follow with milk of magnesia, beaten egg, or vegetable oil. Call a physician immediately.
- **EYES:** Flush with water for 15 minutes and get prompt medical attention.

Batteries produce explosive gases. Keep sparks, flame, cigarettes etc., away. Ventilate when charging or using in an enclosed space. Always shield your eyes when working near batteries.

KEEP OUT OF REACH OF CHILDREN.

Battery storage

When the motorcycle is not used for a month or longer, remove the battery, fully charge it and store it in a cool, dry place.

EC000102

CAUTION:

- **Completely recharge the battery before storing. Storing a discharged battery can cause permanent battery damage.**
- **Use a battery charger designed for a sealed-type (MF) battery. Using a conventional battery charger will cause battery damage. If you do not have a sealed-type battery charger, contact your Yamaha dealer.**
- **Always make sure the connections are correct when reinstalling the battery.**

PERIODIC MAINTENANCE AND MINOR REPAIR

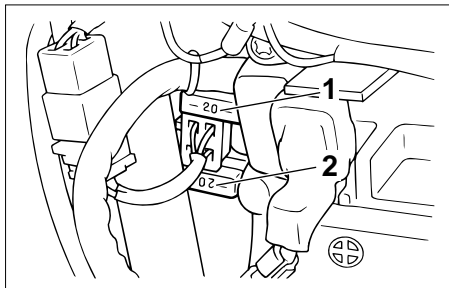

1. Main fuse
2. Spare fuse

EAU01307

Fuse replacement

The fuse is located behind panel A. (See page 6-7 for panel removal and installation procedures.)

If the fuse is blown, turn off the main switch and the switch of the circuit in question. Install a new fuse of proper amperage. Turn on the switches and see if the electrical device operates. If the fuse immediately blows again, consult a Yamaha dealer.

EC000103

CAUTION:

Do not use fuses of higher amperage rating than those recommended. Substitution of a fuse of improper rating can cause extensive electrical system damage and possibly a fire.

Specified fuse:
20 A

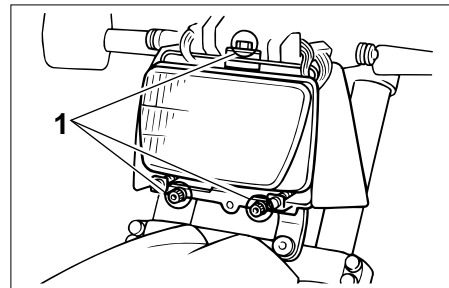

1. Bolt (×3)

EAU01146

Headlight bulb replacement

This motorcycle is equipped with a quartz bulb headlight. If the headlight bulb burns out, replace it as follows:

1. Remove cowling A. (See page 6-7 for cowling removal and installation procedures.)
2. Remove the headlight unit.

PERIODIC MAINTENANCE AND MINOR REPAIR

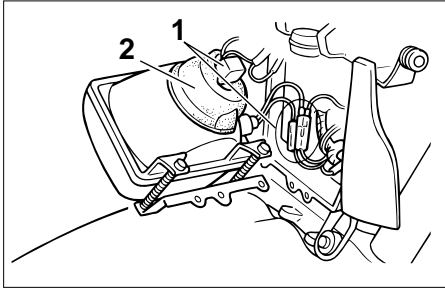

1. Connector (×3)
2. Bulb holder cover
3. Remove the connectors and the bulb holder cover.

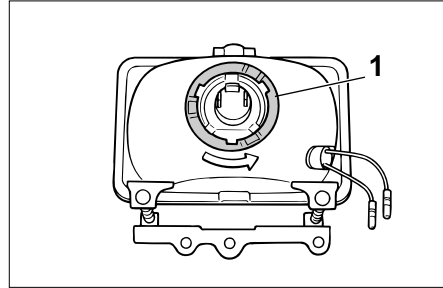

1. Bulb holder
4. Turn the bulb holder counter-clockwise to remove it and remove the defective bulb.

EW000119

WARNING

Keep flammable products and your hands away from a bulb while it is on, as it is hot. Do not touch a bulb until it cools down.

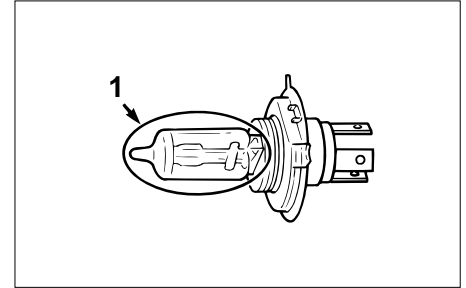

1. Don't touch
5. Put a new bulb into position and secure it in place with the bulb holder.

EC000105

CAUTION:

Avoid touching the glass part of a bulb. Keep it free from oil; otherwise, the transparency of the glass, life of the bulb, and luminous flux will be adversely affected. If oil gets on a bulb, thoroughly clean it with a cloth moistened with alcohol or lacquer thinner.

PERIODIC MAINTENANCE AND MINOR REPAIR

6. Install the bulb holder cover, connectors and headlight unit.
7. Install the cowling.
8. If the headlight beam adjustment is necessary, ask a Yamaha dealer to make that adjustment.

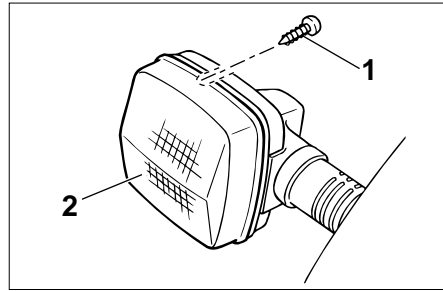

1. Screw
2. Lens

EAU01095

Turn signal light bulb replacement

1. Remove the screw and the lens.

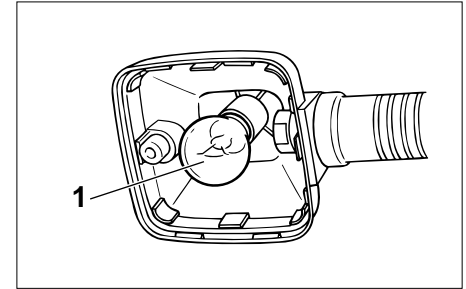

1. Bulb

2. Remove the defective bulb by pushing it inward and turning it counterclockwise.
3. Install a new bulb by pushing it inward and turning it clockwise.
4. Install the lens and tighten the screw.

PERIODIC MAINTENANCE AND MINOR REPAIR

EAU01579

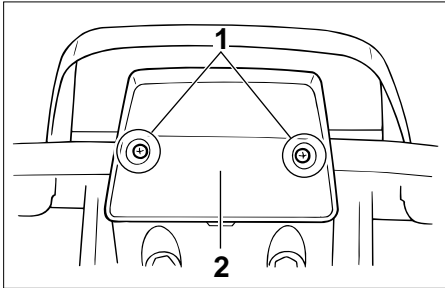

1. Screw (x2)
2. Lens

EAU01623

Taillight bulb replacement

1. Remove the screws and the lens.

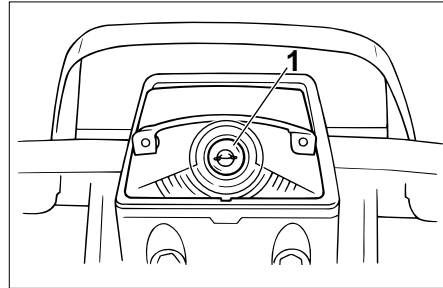

1. Bulb
2. Remove the defective bulb by pushing it inward and turning it counterclockwise.
3. Install a new bulb by pushing it inward and turning it clockwise.
4. Install the lens and tighten the screws.

EC000108

CAUTION: _____

Do not over-tighten the screws as the lens may break.

Supporting the motorcycle

Since the Yamaha XT500E/XT600E has no centerstand, follow these precautions when removing the front and rear wheel or performing other maintenance requiring the motorcycle to stand upright. Check that the motorcycle is in a stable and level position before starting any maintenance. A strong wooden box can be placed under the engine for added stability.

Front wheel service

To stabilize the rear of the motorcycle, either use a motorcycle stand or place a motorcycle jack under the frame in front of the rear wheel to prevent it from moving from side to side. Then use a motorcycle stand to elevate the front wheel off of the ground.

PERIODIC MAINTENANCE AND MINOR REPAIR

Rear wheel service

Use a motorcycle stand or motorcycle jack to elevate the motorcycle so the rear wheel is off the ground. Alternatively, two jacks can be placed under the frame or swingarm.

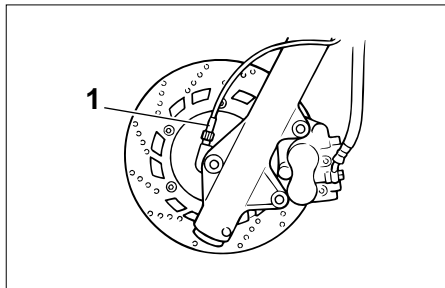

1. Speedometer cable

EAU00897

Front wheel removal

EW000122

⚠ WARNING

- It is advisable to have a Yamaha dealer service the wheel.
- Securely support the motorcycle so there is no danger of it falling over.

1. Remove the speedometer cable from the front wheel side.

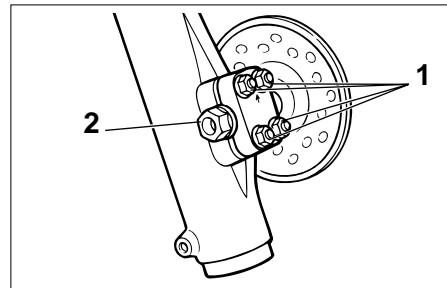

1. Axle holder nut (×4)
2. Wheel axle

2. Loosen the wheel axle holder nuts and wheel axle.
3. Elevate the front wheel by placing a suitable stand under the engine.
4. Remove the wheel axle and the front wheel. Make sure the motorcycle is properly supported.

NOTE:

Do not depress the brake lever when the disc and caliper are separated.

PERIODIC MAINTENANCE AND MINOR REPAIR

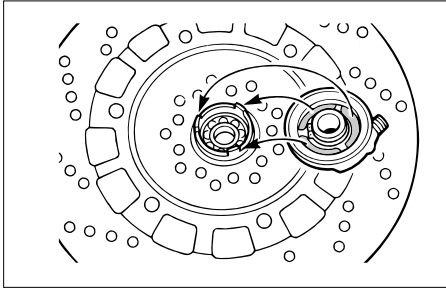

EAU01135

Front wheel installation

1. Install the speedometer gear unit housing into the wheel hub. Make sure the speedometer gear unit housing is installed with the projections meshed into the slots.
2. Lift up the wheel between the front fork legs and guide the brake disc between the brake pads. Make sure there is enough gap between the brake pads before inserting the brake disc.

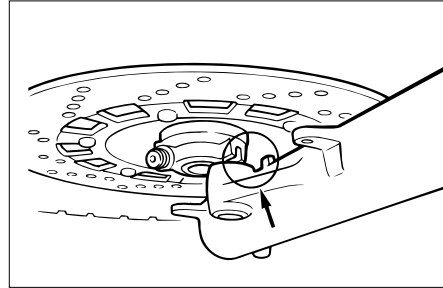

3. Make sure the slot in the speedometer gear unit fits over the stopper on the front fork outer tube.
4. Install the wheel axle and tighten it to the specified torque.

Tightening torque:

Wheel axle:

59 Nm (5.9 m·kg)

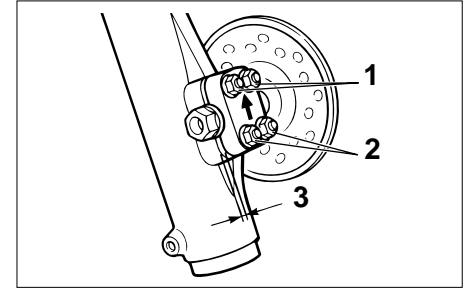

1. Upper nut (x2)
2. Lower nut (x2)
3. Gap

5. Before tightening the holder nuts, push down on the handlebars several times and check if the fork rebounds smoothly.
6. Tighten the axle holder nuts to the specified tightening torque. Tighten the upper nuts first and then lower ones. When tightened in this sequence, there should be a gap formed at the bottom of the axle holder.

PERIODIC MAINTENANCE AND MINOR REPAIR

Tightening torque:
Axle holder nut:
9 Nm (0.9 m·kg)

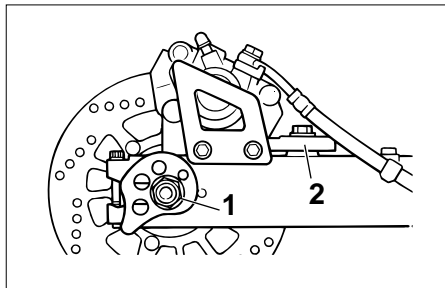

1. Axle nut
2. Caliper bracket bolt

EAU00963*

Rear wheel removal

EW000122

⚠ WARNING

- It is advisable to have a Yamaha dealer service the wheel.
- Securely support the motorcycle so there is no danger of it falling over.

1. Remove the axle nut.
2. Loosen the caliper bracket bolt.

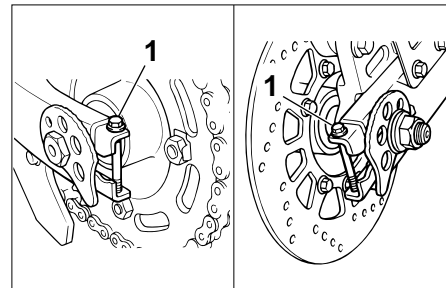

1. Swingarm end bolt (×2)

3. Remove the swingarm end bolts.
4. Elevate the rear wheel by placing a suitable stand under the engine.

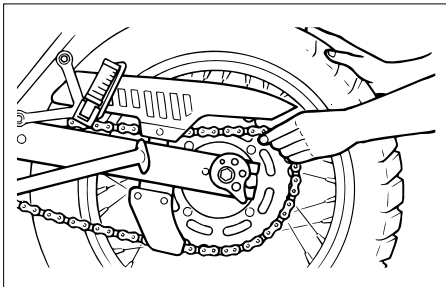

5. Push the wheel forward and remove the drive chain.
6. Pull out the wheel axle, then remove the wheel assembly by pulling backwards.

NOTE:

- Do not depress the brake pedal when the disc and caliper are separated.
- You do not have to disassemble the chain in order to remove or install the rear wheel.

Rear wheel installation

1. Install the rear wheel and chain. Guide the brake disc between the brake pads. Make sure there is enough gap between the brake pads before inserting the brake disc.
2. Make sure the wheel axle is inserted from the left-hand side and that the chain adjusting plates are installed with the punched side outward.
3. Install the swingarm end bolts.
4. Adjust the drive chain.
5. Tighten the following parts to the specified torque.

Tightening torque:

Axle nut:

105 Nm (10.5 m·kg)

Caliper bracket bolt:

48 Nm (4.8 m·kg)

Swingarm end bolt:

2.5 Nm (0.25 m·kg)

Troubleshooting

Although Yamaha motorcycles receive a rigid inspection before shipment from the factory, trouble may occur during operation.

Any problem in the fuel, compression, or ignition systems can cause poor starting and loss of power. The troubleshooting chart describes a quick, easy procedure for making checks.

If your motorcycle requires any repair, bring it to a Yamaha dealer. The skilled technicians at a Yamaha dealership have the tools, experience, and know-how to properly service your motorcycle. Use only genuine Yamaha parts on your motorcycle. Imitation parts may look like Yamaha parts, but they are often inferior. Consequently, they have a shorter service life and can lead to expensive repair bills.

PERIODIC MAINTENANCE AND MINOR REPAIR

Troubleshooting chart

EAU01397

EW000125

⚠ WARNING

Never check the fuel system while smoking or in the vicinity of an open flame.

1. Fuel

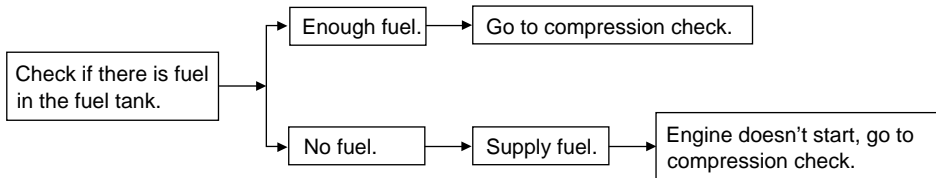

2. Compression

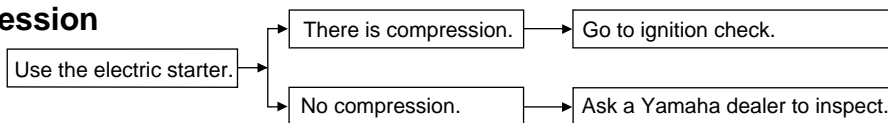

3. Ignition

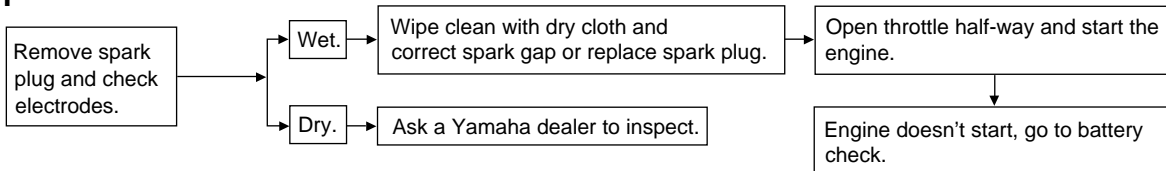

4. Battery

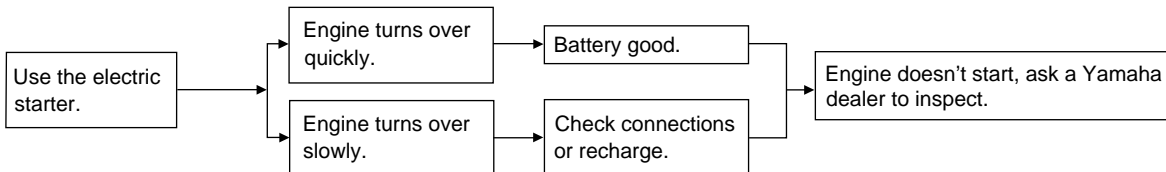

MOTORCYCLE CARE AND STORAGE

Care.....	7-1
Storage.....	7-4

MOTORCYCLE CARE AND STORAGE

Care

The exposure of its technology makes a motorcycle charming but also vulnerable. Although high-quality components are used, they are not all rust-resistant. While a rusty exhaust pipe may remain unnoticed on a car, it does look unattractive on a motorcycle. Frequent and proper care, however, will keep your motorcycle looking good, extend its life and maintain its performance. Moreover, the warranty states that the vehicle must be properly taken care of. For all these reasons, it is recommended that you observe the following cleaning and storing precautions.

Before cleaning

1. Cover up the muffler outlet with a plastic bag.
2. Make sure that all caps and covers as well as all electrical couplers and connectors, including the spark plug cap, are tightly installed.
3. Remove extremely stubborn dirt, like oil burnt onto the crankcase, with a degreasing agent and a tooth or bottle brush, but never apply such products onto seals, gaskets, sprockets, the drive chain and wheel axles. Always rinse the dirt and degreaser off with water.

Cleaning

After normal use

Remove dirt with warm water, a neutral detergent and a soft clean sponge, then rinse with plenty of clean water. Use a brush for hard-to-reach parts. Tougher dirt and insects will come off more easily if the area is covered with a wet cloth for a few minutes before cleaning.

ECA00010

CAUTION: _____

- **Avoid using strong acidic wheel cleaners, especially on spoked wheels. If you do use such products for hard-to-remove dirt, do not leave it on any longer than instructed, then thoroughly rinse it off with water, immediately dry the area and apply a corrosion protection spray.**

MOTORCYCLE CARE AND STORAGE

- Improper cleaning can damage windshields, cowlings, panels and other plastic parts. Use only a soft, clean cloth or sponge with mild detergent and water to clean plastic.
 - Do not use any harsh chemical products on plastic parts. Be sure to avoid using cloths or sponges which have been in contact with strong or abrasive cleaning products, solvent or thinner, fuel (gasoline), rust removers or inhibitors, brake fluid, antifreeze or electrolyte.
 - Do not use high-pressure washers or steam-jet cleaners since they cause water seepage and deterioration in the following areas: seals (of wheel bearings, swingarm bearings, forks and brakes), electric components (couplers, connectors, instruments, switches and lights), breather hoses and vents.
 - For motorcycles equipped with a windshield: Do not use strong cleaners or hard sponges as they will cause dulling or scratching. Some cleaning compounds for plastic may leave scratches on the windshield. Test the product on a small hidden part of the windshield to make sure they do not leave any marks. If the windshield is scratched, use a quality plastic polishing compound after washing.
-

After riding in the rain, near the sea or on salt-sprayed roads.

Since sea salt or salt sprayed on the roads in the winter are extremely corrosive in combination with water, carry out the following steps after each ride in the rain, near the sea or on salt-sprayed roads. (Salt sprayed in the winter may remain on the roads well into spring.)

1. Clean your motorcycle with cold water and soap after the engine has cooled down.

ECA00012

CAUTION: _____

Do not use warm water since it increases the corrosive action of the salt.

2. Be sure to apply a corrosion protection spray on all (even chrome- and nickel-plated) metal surfaces to prevent corrosion.

MOTORCYCLE CARE AND STORAGE

After cleaning

1. Dry the motorcycle with a chamois or an absorbing cloth.
2. Immediately dry the drive chain and lubricate it to prevent it from rusting.
3. Use a chrome polish to shine chrome, aluminum and stainless-steel parts, including the exhaust system. (Even the thermally induced discoloring of stainless-steel exhaust systems can be removed through polishing.)
4. To prevent corrosion, it is recommended to apply a corrosion protection spray on all (even chrome- and nickel-plated) metal surfaces.
5. Use spray oil as a universal cleaner to remove any remaining dirt.
6. Touch up minor paint damage caused by stones, etc.
7. Wax all painted surfaces.
8. Let the motorcycle dry completely before storing it or covering it.

EWA00001

⚠ WARNING

Make sure that there is no oil or wax on the brakes and tires. If necessary, clean the brake discs and linings with a regular brake disc cleaner or acetone, and wash the tires with warm water and mild soap. Then, carefully test the motorcycle for its braking performance and cornering behavior.

ECA00013

CAUTION:

- **Apply spray oil and wax sparingly and wipe off any excess.**
 - **Never apply oil or wax on rubber and plastic parts, but treat them with a suitable care product.**
 - **Avoid using abrasive polishing compounds as they wear away the paint.**
-

NOTE:

Consult a Yamaha dealer for advice on what products to use.

Storage

Short-term

Always store your motorcycle in a cool, dry place and, if necessary, protect it against dust with a porous cover.

ECA00014

CAUTION:

- **Storing the motorcycle in a poorly ventilated room or covering it with a tarp while it is still wet will allow water and humidity to seep in and cause rust.**
 - **To prevent corrosion, avoid damp cellars, stables (because of the presence of ammonia) and areas where strong chemicals are stored.**
-

Long-term

Before storing your motorcycle for several months:

1. Follow all the instructions in the “Care” section of this chapter.
2. Drain the carburetor float chamber by loosening the drain bolt; this will prevent fuel deposits from building up. Pour the drained fuel into the fuel tank.
3. Only for motorcycles equipped with a fuel cock which has an “OFF” position: Turn the fuel cock to “OFF”.
4. Fill up the fuel tank and add fuel stabilizer (if available) to prevent the fuel tank from rusting and the fuel from deteriorating.
5. Perform the following steps to protect the cylinder, piston rings, etc. from corrosion.

- a. Remove the spark plug cap and spark plug.
- b. Pour a teaspoonful of engine oil into the spark plug bore.
- c. Install the spark plug cap onto the spark plug and place the spark plug on the cylinder head so that the electrodes are grounded. (This will limit sparking during the next step.)
- d. Turn the engine over several times with the starter. (This will coat the cylinder wall with oil.)
- e. Remove the spark plug cap from the spark plug, install the spark plug and then the spark plug cap.

EWA00003

WARNING

When turning the engine over, be sure to ground the spark plug electrodes to prevent damage or injury from sparking.

MOTORCYCLE CARE AND STORAGE

6. Lubricate all control cables and the pivoting points of all levers and pedals as well as of the sidestand/centerstand.
7. Check and, if necessary, correct the tire air pressure, then raise the motorcycle so that both of its wheels are off the ground. Alternatively, turn the wheels a little every month in order to prevent the tires from becoming degraded in one spot.
8. Cover up the muffler outlet with a plastic bag to prevent moisture from entering.
9. Remove the battery and fully charge it. Store it in a cool, dry place and recharge it once a month. Do not store the battery in an excessively cold or warm place (less than 0°C or more than 30°C). For more information, see “Battery storage” in the chapter “PERIODIC MAINTENANCE AND MINOR REPAIRS”.

NOTE: _____

Make any necessary repairs before storing the motorcycle.

Specifications	8-1
HOW TO USE THE CONVERSION TABLE.....	8-5

SPECIFICATIONS

Specifications

Model	XT500E/XT600E
Dimensions	
Overall length	2,220 mm 2,295 mm (N, S, CH only)
Overall width	865 mm 825 mm (CH only)
Overall height	1,205 mm
Seat height	855 mm
Wheel base	1,440 mm
Minimum ground clearance	230 mm
Minimum turning radius	2,300 mm
Basic weight (with oil and full fuel tank)	176 kg 172 kg (CH only)
Engine	
Engine type	Air-cooled 4-stroke, SOHC, gasoline
Cylinder arrangement	Forward inclined single cylinder
Displacement	499 cm ³ 595 cm ³
Bore × Stroke	87.0 × 84.0 mm (XT500E) 95.0 × 84.0 mm (XT600E)
Compression ratio	8.5:1
Starting system	Electric starter
Lubrication system	Dry sump

Engine oil

Type

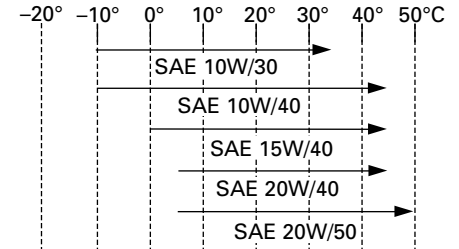

Recommended engine oil classification

API Service SE, SF, SG type or higher

CAUTION:

Be sure to use motor oils that do not contain anti-friction modifiers. Passenger car motor oils (often labeled "Energy Conserving") contain anti-friction additives which will cause clutch and/or starter clutch slippage, resulting in reduced component life and poor engine performance.

Capacity

Periodic oil change	2.7 L
With oil filter replacement	2.8 L
Total amount	3.3 L

SPECIFICATIONS

Air filter	Dry type element
Fuel	
Type	Regular unleaded gasoline
Fuel tank capacity	15 L
Reserve amount	2 L
Carburetor	
Type/quantity	Y26PV/1
Manufacturer	TEIKEI
Spark plug	
Type/Manufacturer	DPR8EA-9 or DPR9EA-9/NGK
Spark plug gap	0.8 ~ 0.9 mm
Clutch type	Wet, multiple-disc
Transmission	
Primary reduction system	Spur gear
Primary reduction ratio	74/31 (2.387) (XT500E) 71/34 (2.088) (XT600E)
Secondary reduction system	Chain drive
Secondary reduction ratio	38/15 (2.533) (XT500E) 45/15 (3.000) (XT600E)
Transmission type	Constant mesh 5-speed
Operation	Left foot operation

Gear ratio	1st	2.583
	2nd	1.588
	3rd	1.200
	4th	0.954 (XT500E) 0.955 (XT600E)
	5th	0.792

Chassis

Frame type	Diamond
Caster angle	27.75° (XT500E) 27°45' (XT600E)
Trail	120 mm

Tire

Type	With tube
Front	
Size	90/90-21 54S
Manufacturer/ model	BRIDGESTONE/TW47 DUNLOP/TRAIL MAX L
Rear	
Size	120/90/17 64S
Manufacturer/ model	BRIDGESTONE/TW48 DUNLOP/TRAIL MAX
Maximum load*	176 kg (XT500E) 180 kg (XT600E)

SPECIFICATIONS

Air pressure (cold tire)

up to 90 kg load*

Front 150 kPa (1.50 kg/cm², 1.50 bar)

Rear 150 kPa (1.50 kg/cm², 1.50 bar)

90 kg load ~ Maximum load*

Front 150 kPa (1.50 kg/cm², 1.50 bar)

Rear 225 kPa (2.25 kg/cm², 2.25 bar)

Off-road riding

Front 125 kPa (1.25 kg/cm², 1.25 bar)

Rear 125 kPa (1.25 kg/cm², 1.25 bar)

High speed riding

Front 150 kPa (1.50 kg/cm², 1.50 bar)

Rear 150 kPa (1.50 kg/cm², 1.50 bar)

* Load is total weight of cargo, rider, passenger and accessories.

Wheels

Front

Type Spoke wheel

Size 21 × 1.85

Rear

Type Spoke wheel

Size 17 × MT2.50

Brakes

Front

Type Single disc brake

Operation Right hand operation

Fluid DOT 3 or DOT 4

Rear

Type Single disc brake

Operation Right foot operation

Fluid DOT 4

Suspension

Front

Type Telescopic fork

Rear

Type Swingarm (new monocross)

Shock absorber

Front Coil spring/oil damper

Rear Coil spring/gas-oil damper

Wheel travel

Front 225 mm

Rear 200 mm

Electrical

Ignition system	T.C.I. (Digital)
Charging system	
Type	A.C. magneto
Standard output	14 V, 13.5A@5,000 rpm
Battery	
Type	YTX9-BS
Voltage, capacity	12 V, 8 AH

Headlight bulb type Halogen bulb

Bulb voltage, wattage × quantity

Headlight	12 V, 60/55W × 1
Tail / brake light	12 V, 5/21W × 1
Auxiliary light	12 V, 4W × 1 12 V, 3.4W × 1 (GB only)
Front flasher light	12 V, 21W × 2
Rear flasher light	12 V, 21W × 2
Meter light	12 V, 3.4W × 1
Neutral indicator light	12 V, 3.4W × 1
High beam indicator light	12 V, 3.4W × 1
Turn indicator light	12 V, 3.4W × 1

Fuse

Main	20A
------	-----

SPECIFICATIONS

EAU01064

HOW TO USE THE CONVERSION TABLE

All specification data in this manual are listed in SI and METRIC UNITS.

Use this table to convert METRIC unit data to IMPERIAL unit data.

Ex.

METRIC		MULTIPLIER	=	IMPERIAL
** mm	×	0.03937	=	** in
2 mm	×	0.03937	=	0.08 in

CONVERSION TABLE

METRIC TO IMPERIAL			
	Metric unit	Multiplier	Imperial unit
Torque	m • kg	7.233	ft • lb
	m • kg	86.794	in • lb
	cm • kg	0.0723	ft • lb
	cm • kg	0.8679	in • lb
Weight	kg	2.205	lb
	g	0.03527	oz
Speed	km/hr	0.6214	mph
Distance	km	0.6214	mi
	m	3.281	ft
	m	1.094	yd
	cm	0.3937	in
Volume/ Capacity	mm	0.03937	in
	cc (cm3)	0.03527	oz (IMP liq.)
	cc (cm3)	0.06102	cu • in
	lt (liter)	0.8799	qt (IMP liq.)
Misc.	lt (liter)	0.2199	gal (IMP liq.)
	kg/mm	55.997	lb/in
	kg/cm2	14.2234	psi (lb/in2)
	Centigrade(°C)	9/5 + 32	Fahrenheit(°F)

Identification number records	9-1
Key identification number	9-1
Vehicle identification number.....	9-1
Model label	9-2

CONSUMER INFORMATION

EAU02944

Identification number records

Record the key identification number, vehicle identification number and model label information in the spaces provided for assistance when ordering spare parts from a Yamaha dealer or for reference in case the vehicle is stolen.

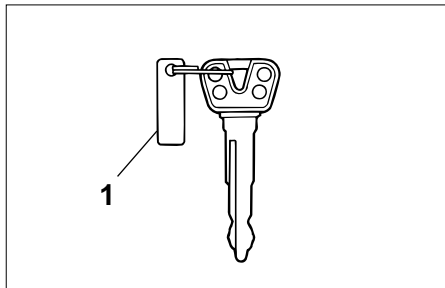

1. Key identification number

EAU01041

Key identification number

The key identification number is stamped on the key tag. Record this number in the space provided and use it for reference when obtaining a new key.

1. KEY IDENTIFICATION NUMBER:

2. VEHICLE IDENTIFICATION NUMBER:

3. MODEL LABEL INFORMATION:

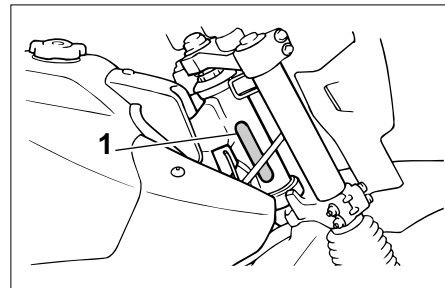

1. Vehicle identification number

EAU01043

Vehicle identification number

The vehicle identification number is stamped into the steering head pipe. Record this number in the space provided.

NOTE:

The vehicle identification number is used to identify your motorcycle and may be used to register your motorcycle with the licensing authority in your state.

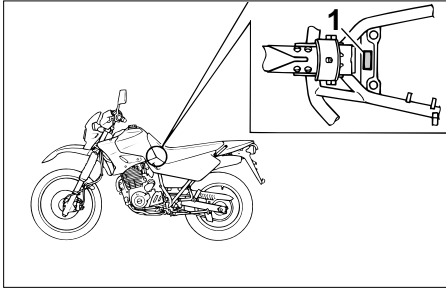

1. Model label

EAU01050

Model label

The model label is affixed to the frame under the seat. (See page 3-9 for seat removal procedures.)

Record the information on this label in the space provided. This information will be needed to order spare parts from your Yamaha dealer.

INDEX

A

Air filter6-12

B

Battery6-28

Brake and clutch lever lubrication6-25

Brake and shift pedal lubrication6-25

Brake fluid replacement.....6-22

Brake light switch adjustment.....6-20

C

Cable inspection and lubrication6-24

Carburetor adjustment.....6-13

Care.....7-1

Carrier (optional)3-11

Checking the front and rear brake

 pads6-20

Clutch lever3-4

Clutch lever free play adjustment6-18

Cowling A6-7

Cowling and panel removal and

 installation6-6

D

Description2-1

Dimmer switch.....3-3

Drive chain lubrication6-23

Drive chain slack adjustment.....6-23

Drive chain slack check6-22

E

Engine break-in5-5

Engine oil.....6-10

Engine stop switch3-4

F

Front brake lever3-5

Front brake lever free play

 adjustment6-18

Front fork inspection.....6-26

Front wheel installation.....6-34

Front wheel removal.....6-33

Fuel3-6

Fuel cock3-7

Fuel tank cap.....3-6

Fuse replacement.....6-29

H

Handlebar switches3-3

 Dimmer switch3-3

 Engine stop switch.....3-4

 Horn switch3-3

 Lights switch3-3

 Pass switch.....3-3

 Start switch3-4

 Turn signal switch3-3

Headlight bulb replacement.....6-29

Helmet holder3-9

High beam indicator light.....3-2

Horn switch.....3-3

How to use the conversion table9-3

I

Identification number records9-1

Idle speed adjustment6-14

Indicator lights3-2

 High beam indicator light3-2

 Neutral indicator light3-2

 Turn indicator light3-2

Inspecting the brake fluid level.....6-21

K

Key identification number9-1

L

Lights switch.....3-3

M

Main switch/Steering lock.....3-1

Model label9-2

N

Neutral indicator light.....3-2

P

Panel A, B6-7

Parking5-6

Pass switch3-3

Periodic maintenance and

 lubrication chart6-3

Pre-operation check list.....4-1

R

Rear brake pedal.....3-5

Rear brake pedal height adjustment6-19

Rear shock absorber adjustment3-10

Rear suspension lubrication6-26

Rear wheel installation6-36

Rear wheel removal6-35

Recommended shift point

 (for Switzerland only)5-4

S

Seat3-9

Shift pedal3-5

Shifting5-4

Sidestand3-11

Sidestand lubrication6-25

Sidestand/clutch switch operation check	3-12
Spark plug	6-8
Specifications	8-1
Speedometer	3-2
Start switch	3-4
Starter (choke)	3-8
Starting a warm engine	5-3
Starting the engine	5-1
Steering inspection	6-27
Storage	7-4
Supporting the motorcycle	6-32
T	
Tachometer	3-3
Taillight bulb replacement	6-32
Throttle cable and grip lubrication	6-24
Throttle cable free play adjustment	6-14
Tips for reducing fuel consumption	5-5
Tires	6-15
Tool kit	6-1
Troubleshooting	6-36
Troubleshooting chart	6-37
Turn indicator light	3-2
Turn signal light bulb replacement	6-31
Turn signal switch	3-3
V	
Valve clearance adjustment	6-15
Vehicle identification number	9-1
W	
Wheel bearings	6-27
Wheels	6-17



PRINTED ON RECYCLED PAPER

PRINTED IN JAPAN
2001.1-1.0x1(E) 